

STATION TRANSFORMERS IDENTIFICATION

1. GENERAL

1.01 This section is reissued to:

- Include KS-20426L3 transformer
- Change Read, 8.03
- Replace Table B

1.02 Locate transformers where they will be accessible for inspection and maintenance.

1.03 Transformers discussed in this section require a 110- to 125-volt ac power service outlet.



Make sure that the 110- to 125-volt power service outlet is not under control of a switch.

1.04 To prevent accidental removal, power cords may be fastened to the 110- to 125-volt ac outlet with a power-cord plug-retainer assembly (Section 167-400-210) and plug-in transformers may be secured with a 2A clamp. A clamp is furnished with the KS-20426L3 transformer.

2. 393B TRANSFORMER

2.01 The 393B transformer (Fig. 1) is used primarily as a power supply for 10-volt lamps in 1A, 1A1, and 1A2 key telephone systems. It is furnished in a metal box with a removable cover. The box is approximately 8-3/4 inches long, 4-1/4 inches high, and 4 inches deep.

2.02 The 393B transformer is equipped with two 2-amp fuses in parallel and furnishes 9 to 11-volts at 2.8 amps. It will handle the load of seventy-two 51A lamps or equivalent.



The 24-type fuses of later design are manufactured with a metallic surface on one side only. When placing these fuses in the 393B transformer, be sure

the nonmetallic sides of the fuses are together on the center post (Fig. 1).

2.03 When more than 18 lamps are supplied by each 2-amp fuse, the leads from the 393B transformer to the key equipment should be 20 gauge or larger.

2.04 The lamp feed leads must be fused again at the key equipment with a 2-amp fuse as shown in Fig. 2.

2.05 Connect the leads from the 393B transformer to the key equipment as shown in Table A.

3. 2012A TRANSFORMER

3.01 The 2012A transformer (Fig. 3) supersedes the KS-16184L3 transformer.

3.02 The 2012A-42 transformer is rated MD and is replaced by the 2012A-49 (light olive gray) and 2012A-50 (ivory).

3.03 The 2012A transformer supplies power for telephone sets with dial night light feature.



Do not use 2012A transformer to power 3A speakerphone systems.

3.04 This transformer is self-protecting. Prongs for the primary terminals are provided so that the transformer can be mounted in a standard parallel-blade convenience receptacle. Screw terminals are provided for secondary winding in a recess on the same side of apparatus as the prongs.

3.05 With 115-volts 60 Hz applied to the primary winding, the secondary winding delivers approximately 7 volts at 0.250 amp.

3.06 Only one dial light or night light may be connected to a 2012A transformer. A 25-foot mounting cord is not recommended because the



Fig. 1—393B Transformer, Cover Removed

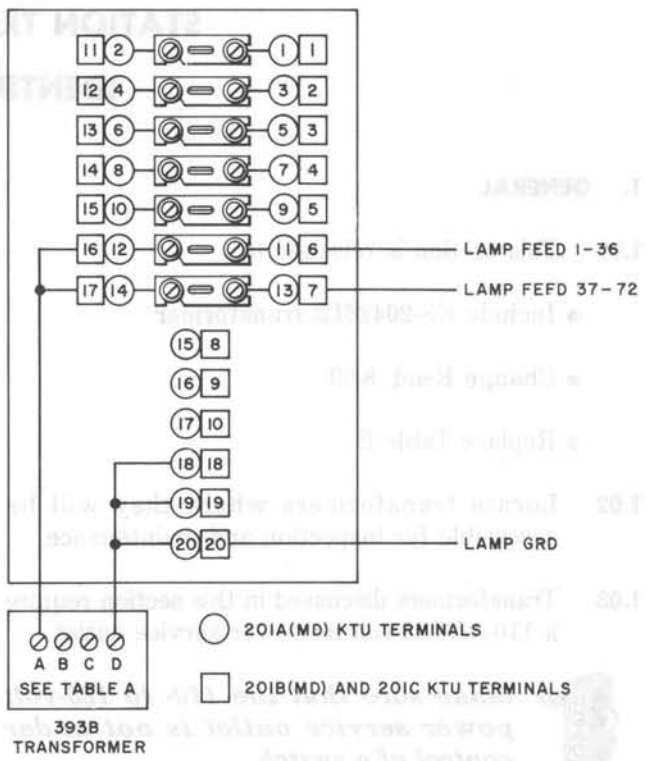

Fig. 2—201A (MD), 201B (MD), and 201C Key Telephone Units

TABLE A
TRANSFORMER CONNECTIONS

IF AC SUPPLY VOLTAGE IS	CONNECT THE LEADS FROM THE KEY EQUIP. TO TERM.
110	A and D
115	A and C
120	B and D
125	B and C

added resistance of this cord results in decreased illumination.



It is not necessary to ground a dial night-light transformer. However the telephone protector and/or signaling ground conductor must be connected to the best ground available as outlined in section covering protector and signaling grounds in Division 460.

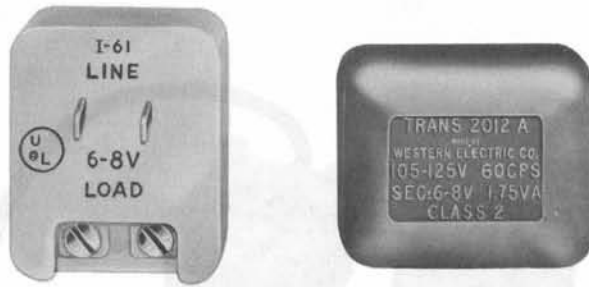

Fig. 3—2012A Transformer



Fig. 4—2012B Transformer

TABLE B

TRANSFORMER LIMITATION

TRANSFORMERS (NOTE)	MAXIMUM NUMBER OF DIAL LIGHT TEL SETS
2012A	1
KS-20426,L3	5
KS-16886,L2 *	10
KS-16940,L1 *	30

* Not recommended for single telephone installations.

Note: Do not use common feeder where more than two sets may be dialed at the same time. Home runs from each set to the transformer provide best illumination. Illumination should be to customers satisfaction.

4. 2012B TRANSFORMER

4.01 The 2012B-42 transformer is rated MD and is replaced by the 2012B-49 (light olive gray) and 2012B-50 (ivory).

4.02 The 2012B transformer (Fig. 4) is primarily intended to supply power to the 55A or 55B control unit in 3A speakerphone systems. The length of wire between the transformer and the control unit should not exceed 100 feet of standard inside wire.



Do not use 2012B transformer as a 2012A transformer.

4.03 This transformer is self-protecting. Prongs for the primary terminals are provided so that the transformer can be mounted in a standard parallel-blade convenience receptacle. Screw terminals are provided for secondary winding in a recess on the same side of apparatus as the prongs.

4.04 With 115 volts 60 Hz applied to the primary winding, the secondary delivers approximately 17 volts at 0.132 amp.

4.05 A 2A clamp may be used to secure the 2012-type transformer to a standard electrical service outlet (Fig. 5) in those locations where the transformer is subject to being accidentally dislodged from the receptacle.



Transformers manufactured after April 1969 have folded blade-type prongs (Fig. 6), which have improved retaining characteristics. Use of the 2A clamp with transformers having folded blade-type prongs will normally not be necessary. Except the KS-20426L3 which has a clamp furnished.

4.06 The 2A clamp is available in light olive gray (-49) and ivory (-50).

5. 2075A TRANSFORMER

5.01 The 2075A transformer (Fig. 7) supplies power (15 to 18 volts) for the 41A dial in the 660-, 662-, 663-, and 664-type telephone sets.

5.02 The transformer is equipped with an 18-inch power cord terminated in a 2-pronged plug.

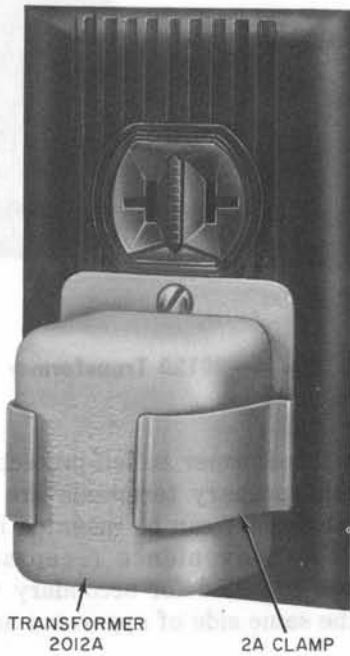

Fig. 5—2A Clamp

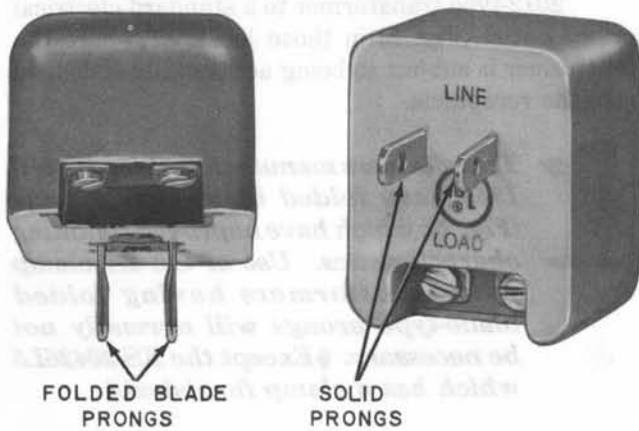

Fig. 6—2012-Type Transformer, Prongs

This plug fits a standard parallel-blade convenience receptacle.

5.03 Keyhole slots are provided at the rear of the transformer for easy installation. Use a suitable backboard when mounting on surfaces requiring backboards.

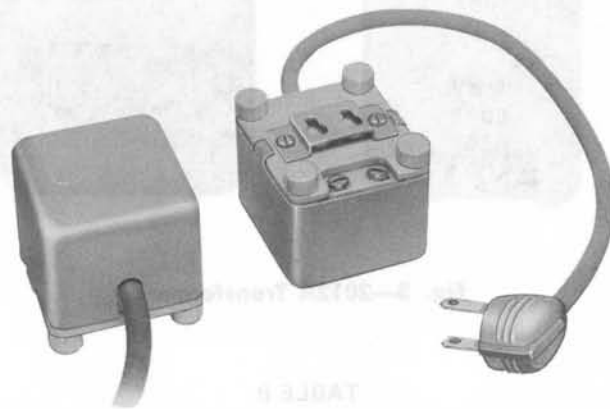

Fig. 7—2075A Transformer

6. 2186A TRANSFORMER

6.01 The 2186A transformer (Fig. 8) supplies power for the 700A and 700B subscriber sets.

6.02 The transformer is protected by an internal thermal overload safety switch which restores automatically. It is equipped with a 12-inch power cord connected to the primary winding. The secondary winding is terminated in screw terminals on the rear of the transformer.

6.03 With 117 volts, 60 Hz applied to the primary winding, the secondary delivers approximately 20 volts at 0.345 amp.

6.04 Keyhole slots are provided at the rear of the transformer for mounting purposes. Use the backboard furnished with the transformer on surfaces requiring backboards.

6.05 Attach backboard with appropriate fastening device depending on the type of mounting surface.

7. KS-5714 TRANSFORMER

7.01 The KS-5714 transformer is used primarily to operate bells, buzzers, and lamps on station systems when the circuits are arranged to supply this load separately. It is furnished in a metal box with a removable cover. The box is approximately 8-3/4 inches long, 4-3/8 inches high, and 4 inches

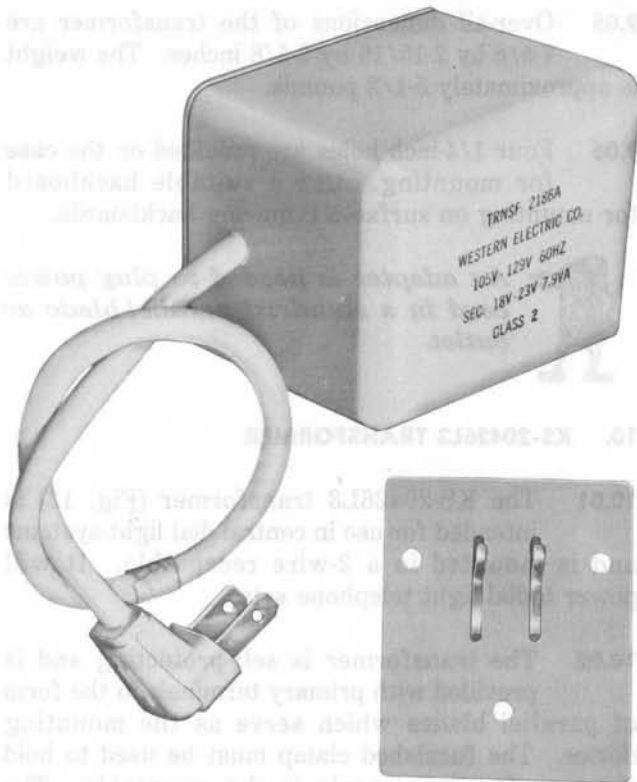

Fig. 8—2186A Transformer

deep, and is arranged for wall mounting. This transformer is self-protecting and has no fuses.

- 7.02** The KS-5714L4 transformer supplies 15-volts ac at 2.2 amps.
- 7.03** The KS-5714L5 transformer supplies 15-volts ac at 1.1 amps.

8. KS-16886, LIST 2 TRANSFORMER

8.01 The KS-16886L2 transformer (Fig. 9) is primarily intended as the centralized power supply for multiphone dial light installations and home interphone systems requiring approximately 6 volts. It is capable of handling up to ten dial light stations. Additional taps at 10.5, 24.0, and 25.5 volts are also provided for other possible uses. This transformer is self-protecting and has no fuses.

8.02 Over-all dimensions of the transformer are 2-3/4 by 3-3/4 by 2-3/4 inches. Power cord

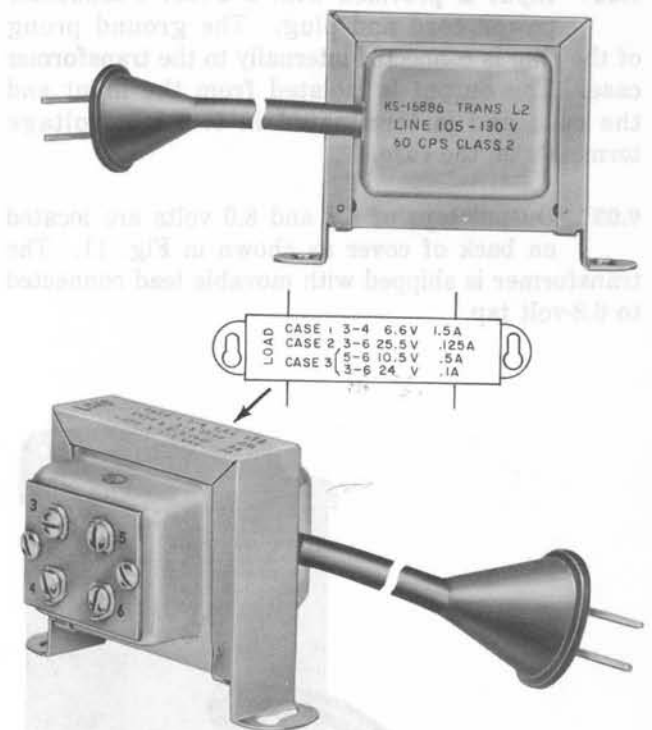

Fig. 9—KS-16886L2 Transformer

is 18 inches long and terminates in a 2-pronged plug. Weight is approximately 1-1/2 pounds.

8.03 Keyhole slots provide easy installation. Use a suitable backboard when mounting on surfaces requiring backboards.



The exposed low-voltage terminals are not hazardous and short circuits across these terminals will not damage the KS-16886L2 transformer. However in instances where frequent customer contact may result in short circuits that will affect service, the transformer may be mounted in a 105C (plastic) apparatus box.

9. KS-16940L1 V.R. TRANSFORMER

9.01 KS-16940L1 V.R. transformer (Fig. 10) is primarily for use as centralized dial light power source to provide regulated power for dial lights and night lights on telephones. It will power 30 dial light telephone sets. This transformer is self-protecting.

9.02 Input is provided with a 2-foot 3-conductor power cord and plug. The ground prong of the plug is connected internally to the transformer case. The output is isolated from the input and the case and is terminated in two low voltage terminals on the case.

9.03 Output taps of 6.3 and 8.0 volts are located on back of cover as shown in Fig. 11. The transformer is shipped with movable lead connected to 6.3-volt tap.



Fig. 10—KS-16940L1 V.R. Transformer

9.04 To change connection to 8.0-volt tap:

- (1) Remove plug from power outlet, if connected.
- (2) Remove two screws holding cover to case.
- (3) Remove cover.
- (4) Change movable lead from 6.3-volt tap to 8.0-volt tap.

9.05 Over-all dimensions of the transformer are 7-5/8 by 2-15/16 by 3-5/8 inches. The weight is approximately 5-1/2 pounds.

9.06 Four 1/4-inch holes are provided on the case for mounting. Use a suitable backboard for mounting on surfaces requiring backboards.



An adapter is needed to plug power cord in a standard parallel-blade ac outlet.

10. KS-20426L3 TRANSFORMER

10.01 The KS-20426L3 transformer (Fig. 12) is intended for use in central dial light systems and is mounted in a 2-wire receptable. It will power 5 dial light telephone sets.

10.02 The transformer is self-protecting and is provided with primary terminals in the form of parallel blades which serve as the mounting device. The furnished clamp must be used to hold the transformer securely in the receptable. The KS-20426L3 transformer mounts in the same manner as the 2012A transformer as shown in (Fig. 5).

10.03 Recessed screw-type secondary terminals are provided on the same side of the apparatus as the primary terminals. With 115 volts 60 Hz applied to the primary winding, the secondary winding delivers approximately 6.38 volts at 750 milliamperes.⚡

11. LENGTHS OF FEEDER PAIRS

11.01 Table B is to be used as a guide only.

After the installation of equipment is made, if illumination is reported as inadequate, then it must be assumed that the lengths of feeder pairs have been exceeded, or too many stations have been off-hook at one time. To remedy this situation do one of the following:

- Double up on the transformer feeder pairs.
- Split the lamp load and add a second transformer.

Illumination should be to customer's satisfaction.

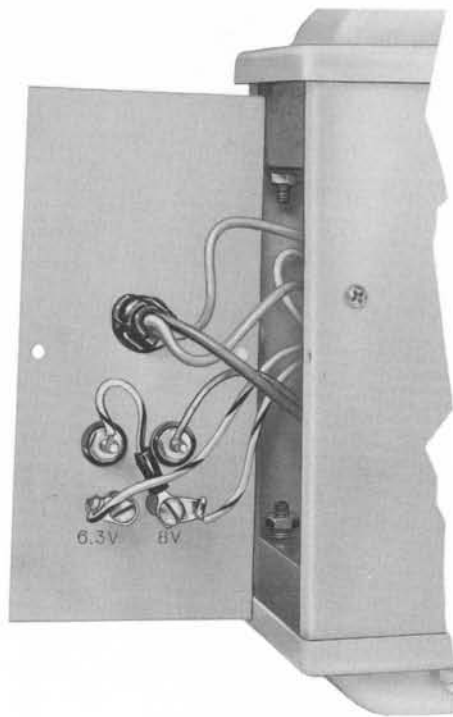
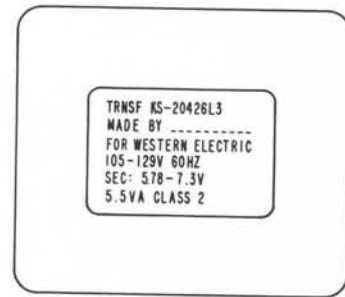
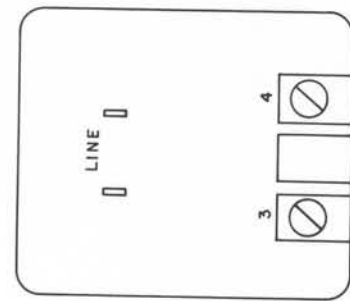

Fig. 11—Movable Lead Connected to 8-Volt Tap



TPA 563678

Fig. 12—KS-20426L3 Transformer