

COIN TELEPHONE STATIONS  
TOOLS, GAUGES, AND MATERIALS

1. GENERAL

1.01 This section covers the identification and use of those tools, gauges, and materials which may be required, in addition to those normally carried, to properly install, modify, or maintain coin collectors and coin telephone sets.

1.02 This section is reissued to add:

- 216B tool
- 787A tool
- Modified P-248585 release tool

1.03 The items listed in this section must be ordered separately as required.

2. TOOLS

<u>NAME</u>	<u>NO.</u>	<u>FIG.</u>	<u>USE</u>	<u>REMARKS</u>
Tool	139B	1	Leveling coins	Read calibrated scale at top of slider
◆Tool	216B	2	Replace information plate assembly, TOUCH-TONE® dial number card, or terminate conductors on 123A1A protector or similar binding post terminals	Dual purpose wrench: 3/8-inch hexagon socket on one end; 7/16 inch-hexagon socket on other end◆
Tool	265C	3	Burnishing contacts	Consists of a chuck having a rubber handle and a magazine. Chuck will hold any No. 266-type tool. Furnished with three No. 266C and six No. 266E tools
Tool	376A	4	Viewing contacts	A magnifying mirror
Tool	466A	5	Adjusting contact springs	
Tool	528A	6	Cleaning out key slots of locks	Consists of two implements in a leather holder. Each implement consists of a piece of music wire with handle
Tool (2 req'd)	641A	7	To facilitate mounting No. 5 dials	An aligning guide
Tool	710A	8	Removing damaged switch-hooks from corner-mounted coin collectors	A hardened steel bar
Tool	719A	9	Opening of door and face-plate assembly (panel phones); removing cover unit assembly (1A-, 1C-type)	
◆Tool	787A	10	To release dimes jammed in coin chute of single slot sets◆	

## SECTION 506-100-103

<u>NAME</u>	<u>NO.</u>	<u>FIG.</u>	<u>USE</u>	<u>REMARKS</u>
Orange Stick	KS-6320	—	Removing stuck coins; tripping hopper trigger	
Nylon Brush	KS-13786	—	Cleaning coin return	
Brush	KS-14164	—	Cleaning washer reject mechanism	
Tool	KS-14995, List 3	11	Trap and vane release test	
Releaser	KS-16750, L4	12	Removing dial finger wheel; resetting totalizer	
Spring Hook	TP-75503	13	Assembling spring on pull bucket	
Release Tool	P-248585	14	Releasing 27A "key snatcher" lock	
	◆ Modified P-248585	15	Releasing 32A "key snatcher" lock◆	
Sash Brush	No. 6	—	General cleaning	
Allen Wrenches	Assorted	—	Adjusting switchhook travel	
Center Punch	—	—	Removing and replacing pull bucket shaft	
Cold Chisel	1/2-in.	—	Removing plastic pull buckets	
Phillips Screw- driver	—	—	Adjusting coin relay	
Spirit Level	—	—	Vertical alignment of coin telephone set	
Spacer	P-12A745	16	Reducing upper housing vertical play	
Spacing Washer	P-297872	—	Reducing switchhook end play	Brass, .438 OD, .297 ID, .010 thk.
Cover Parking Tool	KS-20950, L1	17	To mount cover unit assembly of 1A/1C/1E-type coin telephone set to corner of housing and mounting plate assembly	Permits trouble shooting without use of P11C cord

<u>NAME</u>	<u>NO.</u>	<u>FIG.</u>	<u>USE</u>	<u>REMARKS</u>
<b>3. GAUGES</b>				
Feeler Gauges	131A	18	Adjusting armature travel	
Bias Margin Gauge	146A	19	Coin relay bias margin test	<b>For use on 2-coil coin relay</b>
Bias Margin Gauge	146B	20	Coin relay bias margin test	For use on single-coil relay
Gauge	147A	21	Checking the restoring capability and contact pressure of the coin relay in prepay multislot coin collectors	When mounted on the horizontal portion of the operating arm in front of the stop lugs by the full depth of the slot in the long end, the gauge will exert a torque of $70 \pm 2$ gram-inches on the operating arm in a coin relay.
				When mounted on the switch lever by the three slots in the side, the gauge will exert torques on the switch lever corresponding to pressures of min. 3, min. 5, and max. 7 grams, respectively, on the spring contacts
Gauge	178A	22	Setting the position of the operating arm on coin collectors	Use with coin collectors having shaft-type switchhooks
Gauge	178B	22	Same as 178A	Use with coin collectors having pin-type switchhooks
<b>4. CORDS</b>				
Cord	P10B	23	Maintenance or testing of 236G and 1234G coin collectors with upper housing removed	
Cord	P11C	24	Maintenance or testing of single slot coin-telephone sets with cover unit assembly removed or door and faceplate assembly opened (Also use with 235G and 1235G coin collectors)	

## SECTION 506-100-103

<u>NAME</u>	<u>NO.</u>	<u>FIG.</u>	<u>USE</u>	<u>REMARKS</u>
Cord	P5M	25	Maintenance or testing of 200-type coin collectors with upper housing removed	
<b>5. MATERIALS</b>				
Aluminum Oxide Cloth	No. 320	—	Smoothing rough spots on fork slot on 2-coil relay	
Antiseize Compound	KS-19094, L1 or L2	—	Lock and screw threads	L1 is pre-mixed; L2 must be mixed on site.
Cotton Twill Cloth	KS-2423	—	General cleaning	
Form	E-4914	26	Out-of-service label	Packaged in books of 5
Form	KS-7991	27	Out-of-service sign	
Grease	KS-14774, L1	—	General lubrication	
Lead Pencil	2B or Softer	—	Lubricating switchhook and coin release mechanism	
Paper	KS-16601, L1	—	Cleaning	
Paper Clip	—	—	Dial shorting	
Petroleum Spirits	KS-7860	—	Cleaning	<i>Warning: Highly flammable. Use safety precautions while using.</i>
Pipe Cleaners	—	—	Cleaning coin gauges	
Sealing Compound	6824	—	Sealing bias adjustment screw on coin relay	
Tinnerman Clips	C-29313-012-445 or C-3412-020-38	—	Upper and lower housing ground clips	

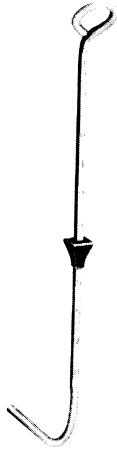

Fig. 1 - 139B Tool

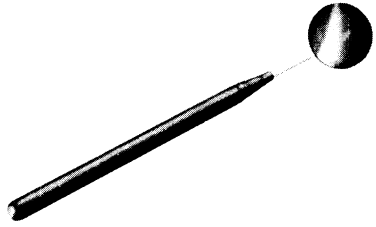

Fig. 4 - 376A Tool

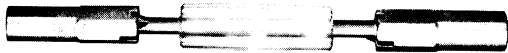

Fig. 2 - 216B Tool

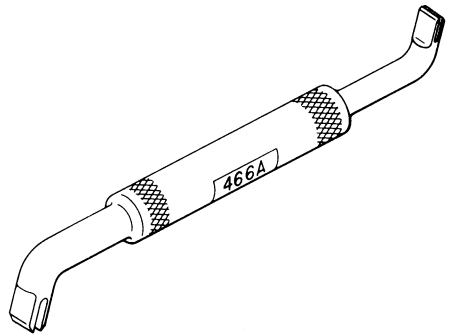

Fig. 5 - 466A Tool

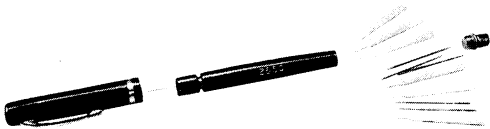

Fig. 3 - 265C Tool

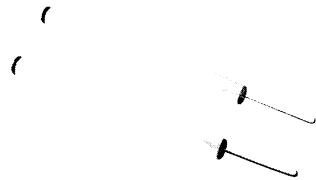

Fig. 6 - 528A Tool

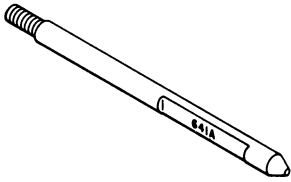

Fig. 7 - 641A Tool

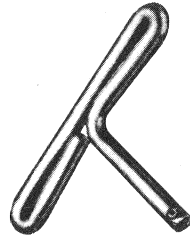

Fig. 9 - 719A Tool

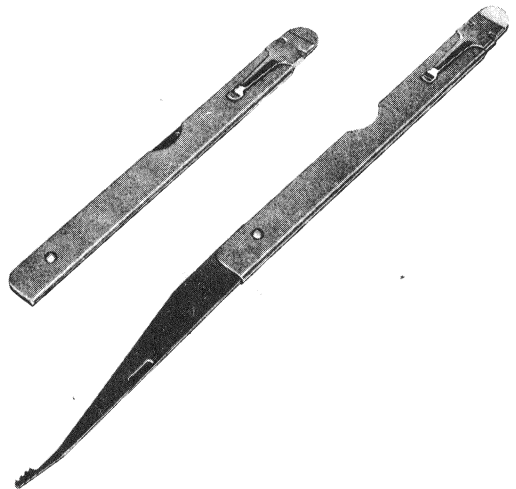
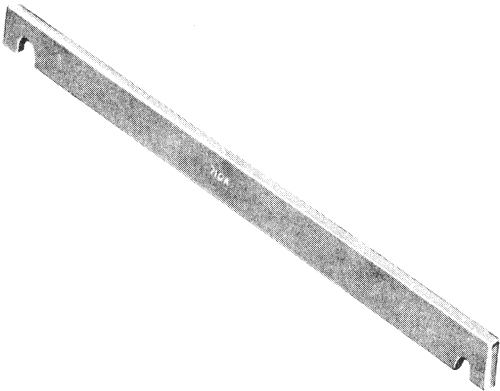

Fig. 10 - 787A Tool

MULTISLOT COIN COLLECTOR MAINTENANCE	SINGLE SLOT COIN TELEPHONE SET MAINTENANCE
INSPECT EXTERIOR Handset, Coins, Dial Cards: Instruction & No Coin Release, Return Bucket	INSPECT EXTERIOR Handset, Coins, Dial Cards: Instruction & No Coin Release, Return Bucket
COIN TESTS 5c, 10c, 25c Dial Tone, Coin Return Trouble Analysis	COIN TESTS 5c, 10c, 25c Dial Tone Coin Return On Hook Coin Return Trouble Analysis
INSPECT INTERIOR Gauge, Connections Security Fasteners Housing Contacts	INSPECT INTERIOR Chute Assembly Connections, Plugs Switchhook
COIN CHUTE Dirt, Corrosion	COIN RELAY Bias Margin, Trap, Vane
SWITCHHOOK Spring Pileups	RESISTANCE TESTS Loop, Ground
COIN RELAY Bias Margin, Trap, Vane	STATION WIRING Ground Connections Protector Booth Ground
RESISTANCE TESTS Loop, Ground	OPERATIONAL TESTS Coins Operator, Ring Back
STATION WIRING Ground Connections Protector Booth Ground	INSPECT BOOTH Glass, Door, Lights Blower, Directories
OPERATIONAL TESTS Coins Operator, Ring Back	KS 14995 L3 TOOL
INSPECT BOOTH Glass, Door, Lights Blower, Directories	

Fig. 11 – KS-14995, List 3 Tool



Fig. 12 – KS-16750, List 4 Releaser

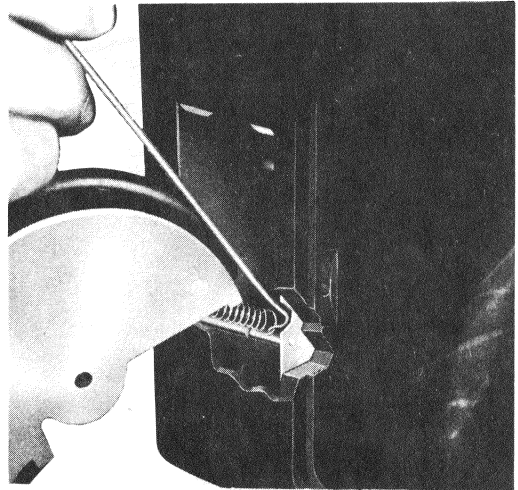

Fig. 13 – TP-75503 Spring Hook

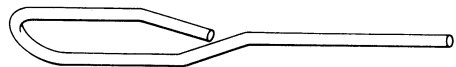

Fig. 14 – P-248585 Release Tool

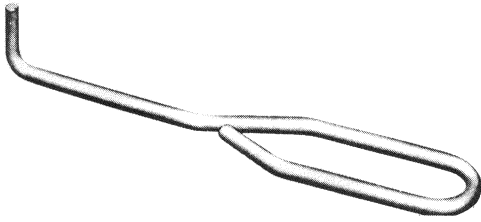

Fig. 15 – Modified P-248585 Release Tool

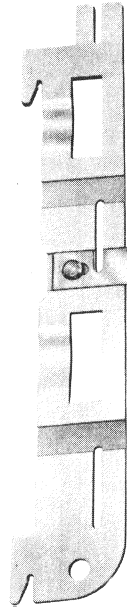

Fig. 17 – KS-20950, List 1 Cover Parking Tool

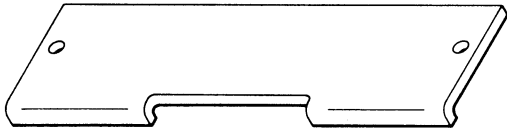

Fig. 16 – P-12A745 Spacer

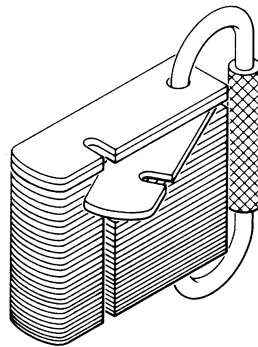

Fig. 18 – 131A Feeler Gauges

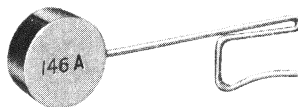

Fig. 19 – 146A Bias Margin Gauge



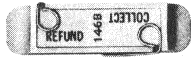

Fig. 20 - 146B Bias Margin Gauge

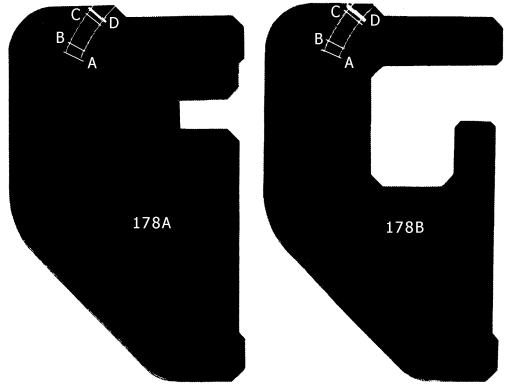

Fig. 22 - 178A and 178B Gauges

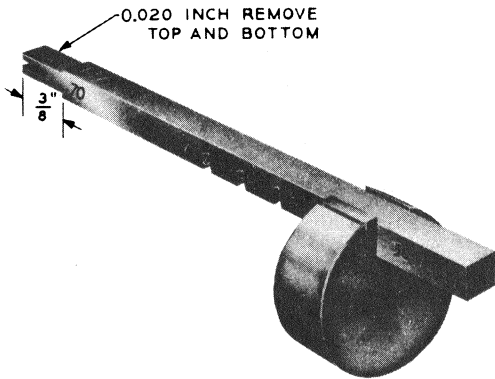

Fig. 21 - 147A Gauge

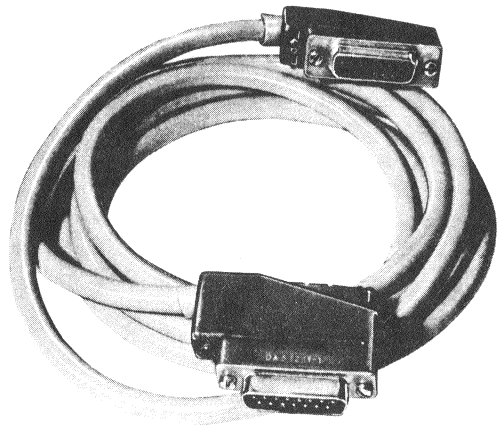

Fig. 23 - P10B Cord

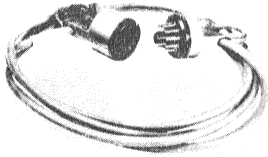

Fig. 24 – P11C Cord



Fig. 26 – E-4914 Form

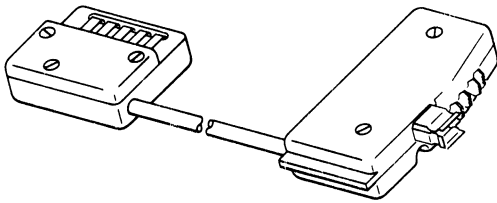

Fig. 25 – P5M Cord

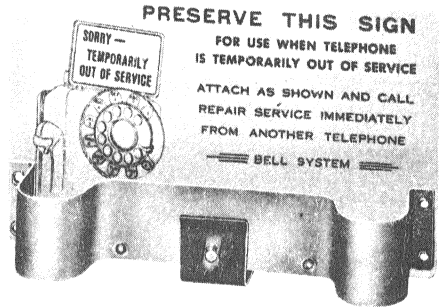

Fig. 27 – KS-7991 Form, Rear View