

# INSTRUCTION MANUAL

 **BK PRECISION®**

## MODEL 1045B

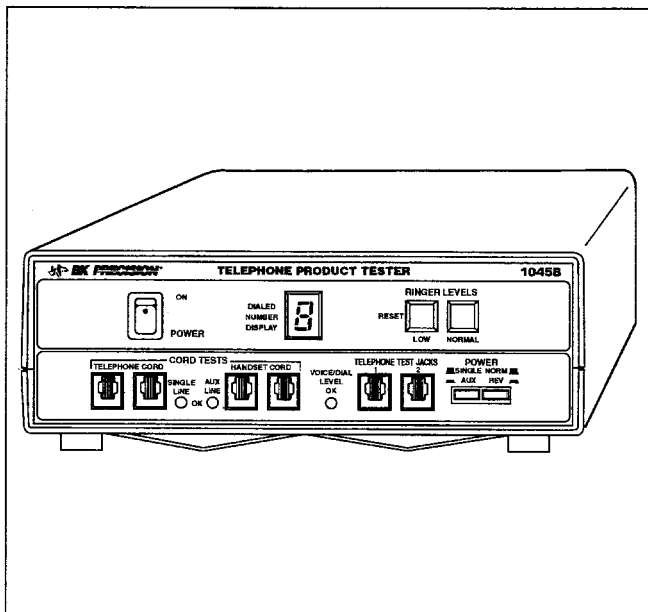

## TELEPHONE PRODUCT TESTER

U.S. Patent No. 4,577,072

 **BK PRECISION®**

---

## TEST INSTRUMENT SAFETY

---

### **WARNING**

An electrical shock causing 10 milliamps of current to pass through the heart will stop most human heartbeats. Voltage as low as 35 volts dc or ac rms should be considered dangerous and hazardous since it can produce a lethal current under certain conditions. Higher voltages pose an even greater threat because such voltage can more easily produce a lethal current. Your normal work habits should include all accepted practices that will prevent contact with exposed high voltage, and that will steer current away from your heart in case of accidental contact with a high voltage. You will significantly reduce the risk factor if you know and observe the following safety precautions:

Do not insert fingers or any metal objects into either TELEPHONE TEST JACK. Whenever tester is on, 52 VDC is present at the jacks. Also, ringing voltages of 45 V rms (LOW) or 100 V rms (NORMAL) are present at TELEPHONE TEST JACK #1, the telephone cord, and the telephone during the ring test. If telephone cord insulation is cracked, nicked, split, or any bare wire is exposed, the cord should be replaced immediately to prevent electrical shock. Do not operate this or any other electrical equipment with protective covers removed. Voltages of 325 VDC and 120 VAC are present inside the Model 1045B Telephone Product Tester; servicing of this or any other electrical instrument should be performed only by qualified electronics technicians trained to work in the presence of high voltage.

---

## TABLE OF CONTENTS

---

	Page		Page
TEST INSTRUMENT SAFETY . . . . .	inside front cover	Automatic Telephone Dialer Test . . . . .	18
INTRODUCTION . . . . .	2	The Telephone Product Tester As A Demonstrator . . . . .	18
FEATURES . . . . .	3	TELEPHONE TROUBLESHOOTING CONSIDERATIONS . . . . .	19
SPECIFICATIONS . . . . .	4	BLOCK DIAGRAM ANALYSIS . . . . .	20
CONTROLS AND INDICATORS . . . . .	6	MAINTENANCE . . . . .	23
OPERATING INSTRUCTIONS . . . . .	8	Opening The Tester . . . . .	23
Cord Test . . . . .	9	Fuse Replacement . . . . .	23
Dial Test . . . . .	11	Line Voltage Conversion . . . . .	23
Telephone Light Test . . . . .	11	Pulse Dial Leakage Jumper . . . . .	23
Ring Test . . . . .	13	Calibration . . . . .	24
Voice Level Test . . . . .	13	Closing The Tester . . . . .	25
Voice Quality Test . . . . .	15	WARRANTY SERVICE INSTRUCTIONS . . . . .	29
Two-Line Telephone Test . . . . .	15	LIMITED ONE-YEAR WARRANTY . . . . .	30
Cordless Telephone Test . . . . .	16	MOUNTING THE INSTRUCTION CARD . . . . .	31
Answering Machine Test . . . . .	16		
Fax Machine Test . . . . .	17		

---

## INTRODUCTION

---

The **B+K PRECISION** Model 1045B Telephone Product Tester performs a wide variety of go/no-go tests on standard and cordless telephones (both pulse and tone dial), two-line telephones, answering machines, fax machines, and automatic dialers. It can be operated by a non-technical person interested in finding out if a problem is caused by the telephone product or the telephone system.

The Telephone Product Tester checks the telephone's cords, ringing mechanism, dialing mechanism, mouthpiece, earpiece, and audio amplifier. A second telephone is not necessary for the testing of a telephone, but a second telephone jack is supplied for the testing of fax machines and answering machines.

Many telephone problems occur because of a faulty cord; therefore, it is advisable to test cords first. If any cord is found to be defective, the other tests should still be carried out after replacing the defective cord. It is advisable to perform all tests on each telephone product tested.

This tester verifies performance of telephone products to be used in normal operating telephone systems. Occasionally, due to variations in telephone systems, a telephone might check out good on this tester yet still fail to work with the telephone system to which it is connected. If this happens, a substitute telephone can be used to verify that the telephone system is operating or the **B+K PRECISION** Model 1042 Telephone Line Analyzer can be used to test the telephone line.

---

## FEATURES

---

### **TESTS ALL TELEPHONE PRODUCTS:**

Checks corded telephones, cordless telephones, two-line telephones, answering machines, fax machines, and automatic dialers.

### **COMPLETE TESTING:**

Good/bad indication for every function of standard telephone.

### **SINGLE TELEPHONE NEEDED:**

Only the telephone being tested is needed for all telephone tests.

### **EASY TO USE:**

Consumer oriented to allow unsupervised use by customers. Instructions are short and easy to follow. For familiar sounds, tester provides dial tone and ring signal that are identical to those supplied by telephone exchange.

### **CORD TEST:**

Checks for shorts, broken or intermittent conductors, and bad connectors.

### **DIAL TEST:**

Decodes dialing signals for both pulse and tone dial telephones and indicates number dialed. Slow sequence display releases approximately two numbers/second so that even rapidly dialed numbers can be easily read. Can also test Redial and Memory dial function of telephone. For tone dial telephones, indicator lights when level is sufficient.

### **RING TEST:**

Two ringer levels selectable: NORMAL and LOW (worst case). LOW level is approximately the minimum value that the telephone company guarantees; NORMAL level is the typical level.

### **VOICE LEVEL TEST:**

Indicator lights when voice level meets or exceeds minimum acceptable level.

### **POLARITY TEST:**

Tests automatic polarity circuit in telephone. Assures that telephone will work if polarity of telephone line is reversed.

### **TWO-LINE TELEPHONE TEST:**

Permits testing of every function of two-line telephone.

### **SECOND TELEPHONE CAPABILITY:**

Permits voice quality of telephone to be checked when a second telephone is available. Fax machines and answering machines can also be tested.

### **TELEPHONE LIGHT TEST:**

Power is applied to telephone jack to test operation of the internal light in a "Princess" type telephone or any telephone with a built-in light. The power is applied to the light only when the SINGLE/AUX switch is in the SINGLE (out) position and the telephone being tested is connected to TELEPHONE TEST JACK 1.

---

## SPECIFICATIONS

---

### GENERAL

**Telephone Line Simulation:**

Single or two telephone operation.

**DC Line Voltage:**

52 V  $\pm 15\%$ , 1.5 k $\Omega$  Source Impedance.

**Current:**

28 mA nominal (off hook).

**Auxiliary Line Voltage:**

5 to 7 VAC, 60 Hz to operate light in telephone.

**Polarity Test Switch:**

Reverses telephone line polarity with momentary switch.

**Single/Aux (Two-Line) Switch:**

Permits testing two-line telephones.

**Voice/Dial Level Indicator:**

Illuminates for levels greater than 0.1 V rms.

**Cord Tests:**

Tests both telephone line and handset 2-wire and 4-wire modular cords for shorts or continuity.

**Reset:**

Sets display to "0" and removes dial tone when activated. Shuts off ring signal when activated.

### RING SOURCE

**Frequency:**

20 Hz.

**Ring Frequency Accuracy**

$\pm 1\%$

**Voltage (2 selectable levels):**

Low - 45 V rms  $\pm 5\%$ ; Normal - 100 V rms  $\pm 5\%$ ; with IREN (ringer equivalent number) load.

**Ring Sine Wave Purity**

Distortion  $\leq 10\%$ ; with IREN load.

**Off-Hook Detection:**

DC line voltage less than 25 volts inhibits ring.

**Ring Cycle:**

After pushbutton selection of voltage level; approx. 2 seconds on, 4 seconds off.

### AUTOMATIC NUMBER IDENTIFICATION

**DTMF (Dual Tone Multiple Frequency):****Tolerance:**

Accepts tones within  $\pm 1.5\%$  of nominal.

**Tone Duration For Identification:**

50m Sec minimum.

**Interdigit Time:**

50m Sec minimum.

**Amplitude Response (Composite Tone):**

0.25 V rms (-10 dBm).

**ROTARY DETECTION:**

**Rate:**

8 to 20 pulses/sec.

**Break Time:**

30m Sec minimum.

**Make Time:**

15m Sec minimum.

**Interdigit Time:**

315m Sec minimum.

**Recognition Time (end of digit):**

100m Sec minimum.

**Pulse Dialing Leakage Detect: (On- Hook)**

Preset to 1 mA ( $\cong$  50 k $\Omega$  On-Hook Impedance). User selectable to 2 mA, 3 mA, 4 mA, or 5 mA via internal jumper.

**Manual Dialing (pulse type and DTMF):**

Detects and decodes number dialed by telephone under test.

**Automatic Dialer and Redial:**

**Pulse Type:** Verifies numbers dialed.

**DTMF:** Uses a delay circuit to verify numbers dialed with rates up to 10 digits/second. Digits are displayed at a rate of 2/second for easy verification.

**DISPLAY**

Single 0.43" 7 segment LED. Delay feature for high speed dialer. Display blanks momentarily to mark display update.

**tone CHARACTERISTICS**

**Dial Tone:**

352 Hz and 440 Hz nominal.

**Dial Tone Accuracy:**

$\pm$ 1%.

**Dial Tone Amplitude(s):**

0.05 V rms nominal.

**Ringback Tone:**

440 Hz and 20 Hz.

**Ringback Tone Amplitude:**

0.026 V rms nominal.

**OPERATING TEMPERATURE:**

0° to +50°C.

**POWER:**

100, 120, 220, 240 VAC  $\pm$ 10%, 50/60 Hz, 25 VA.

**PHYSICAL SIZE:**

HWD (3-3/8" x 10-3/8" x 11-7/16") (8.6 cm x 26.4 cm x 29.1 cm).

**WEIGHT:**

4.4 Pounds (2 kg).

## CONTROLS AND INDICATORS

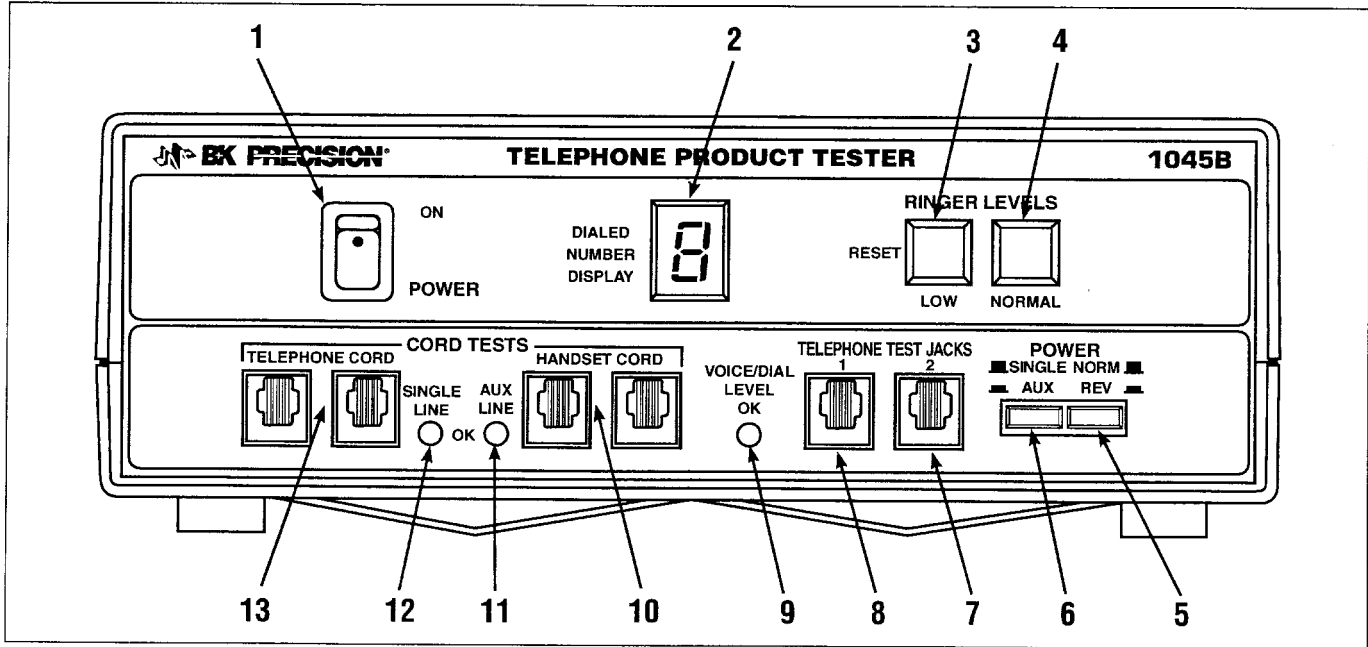

Figure 1. Controls And Indicators



Refer to Fig. 1.

1. **POWER Switch.** Switches tester ON and OFF.
2. **DIALED NUMBER DISPLAY.** Single-digit display. Indicates when power is applied to the tester. Indicates number telephone actually dialed. Display blinks briefly each time a new digit is displayed.
3. **LOW RINGER LEVEL/RESET Button.** Rings telephone under test at low voltage level. Shuts off ring signal if ringing has been initiated. Resets DIALED NUMBER DISPLAY circuitry and causes a "0" to be displayed. Also turns off dial tone.
4. **NORMAL RINGER LEVEL Button.** Rings telephone under test at normal voltage level.
5. **POLARITY NORM/REV Test Button.** Reverses polarity to test telephone's steering diodes.
6. **SINGLE/AUX Button.** Selects main or auxiliary line in two-line telephones.
7. **TELEPHONE TEST JACK #2.** Input for second telephone for testing answering machines and voice quality.
8. **TELEPHONE TEST JACK #1.** Input for telephone product to be tested.
9. **VOICE/DIAL LEVEL OK Indicator.** Lights when dialing tone is above minimum level. Lights on voice peaks when level is above minimum required level.
10. **HANDSET CORD TEST Jacks.** Inputs for testing detachable handset cord.
11. **AUX LINE Indicator.** Indicates condition of two auxiliary wires in detachable cord. The two auxiliary wires carry power to a light in certain telephones, and a second telephone line in two-line telephones.
12. **SINGLE LINE Indicator.** Indicates condition of two main telephone wires in detachable cord. For most telephones, only two phone wires are used.
13. **TELEPHONE CORD TEST Jacks.** Inputs for testing detachable telephone cord (telephone to wall).

## OPERATING INSTRUCTIONS

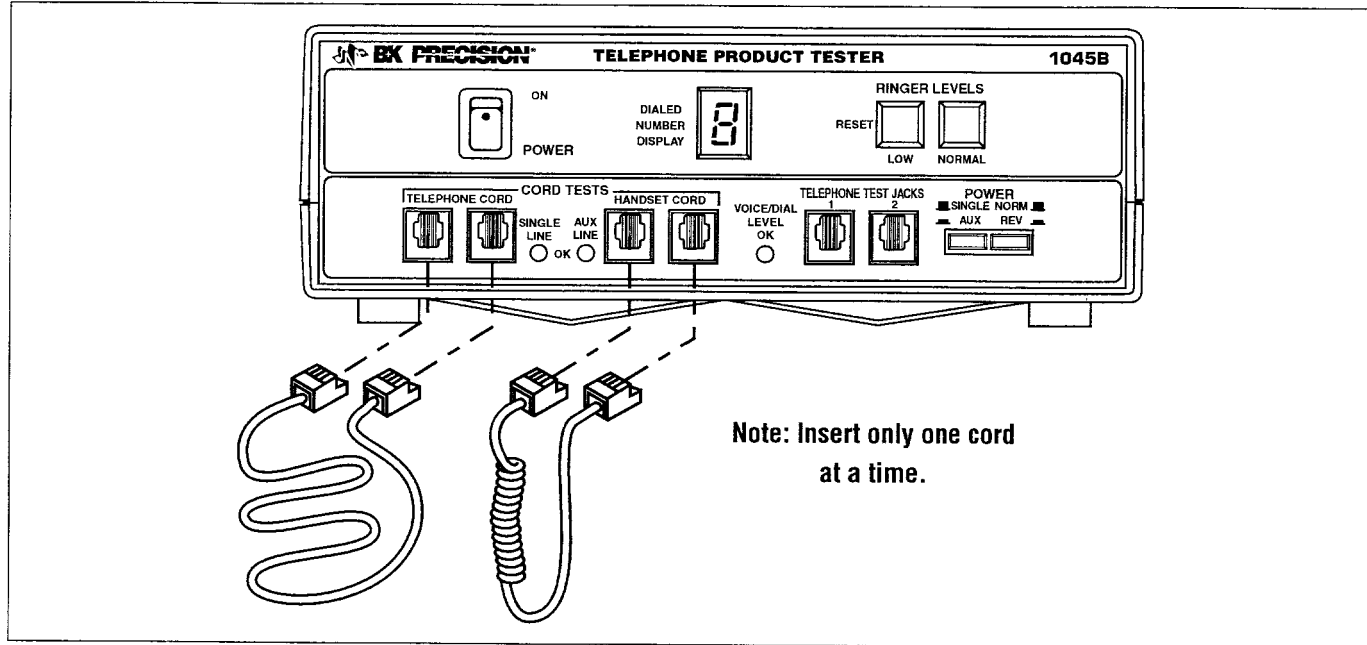

Figure 2. Cord Test Set Up.

**CORD TEST**

(refer to Fig. 3.)

This test is used to check a DETACHABLE handset (handset to desk unit) cord or telephone (telephone to wall) cord (see Fig. 3.). IF CORD IS NOT DETACHABLE AT BOTH ENDS, IT CAN NOT BE TESTED; GO ON TO THE OTHER TESTS. If the telephone cord is found to be in proper working order, any problem is now isolated to the telephone or the telephone company's equipment. If a cord is defective, other tests should still be carried out (after replacing the defective cord) to insure that there is no problem with the telephone itself. Only one cord can be tested at a time. Do not plug in both cords at the same time. Handset and telephone cords are not interchangeable and should not be plugged into the wrong jacks.

1. Toggle the POWER switch ON. The DIALED NUMBER DISPLAY indicator lights when the Telephone Product Tester is on.
2. To test the telephone cord (see Fig. 3. for example of cord type) for continuity or shorts, plug both ends of the cord into the TELEPHONE CORD TEST JACKS. If the SINGLE LINE OK indicator lights, the cord is good for normal telephone operation. If the AUX OK indicator **also** lights, the cord is good for lighted telephone operation or two-line telephones. The SINGLE LINE OK indicator shows the condition of the two wires in the cord used for dialing, ringing, and conversation. The AUX LINE OK indicator shows the condition of the two wires in the cord that carry power to the night light in a telephone or the auxiliary line in two-line telephones. If the indicators fail to light, the cord is defective. Gently bend and

squeeze the cord to check for intermittent continuity or shorts. If the indicators go out or flicker, the cord should be replaced.

3. Next, use the HANDSET CORD test jacks to test the handset cord in the same manner as the telephone cord.

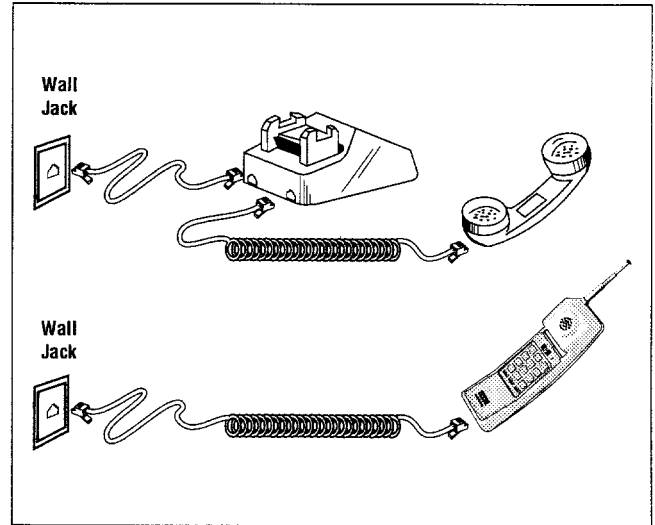

Figure 3. Telephone Cord and Handset Cord.

## OPERATING INSTRUCTIONS

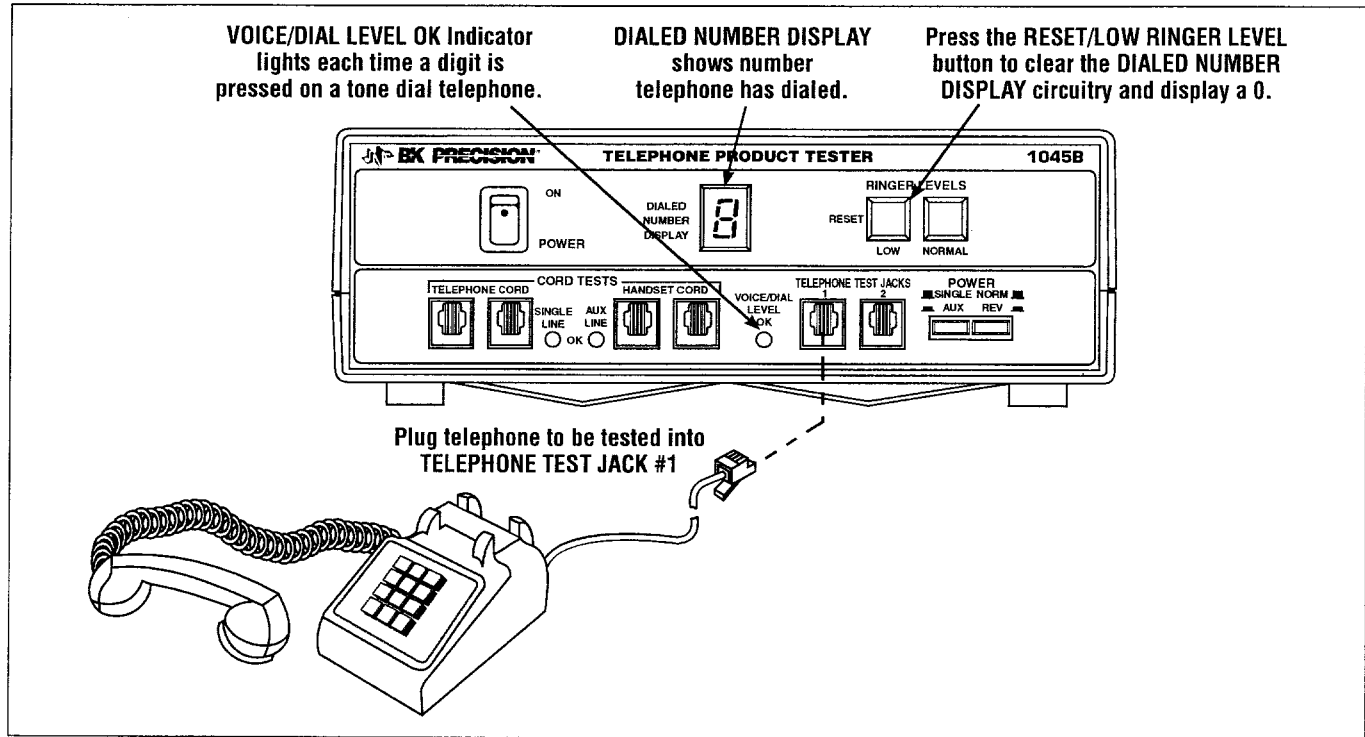

Figure 4. Dial Test Set Up.

**DIAL TEST**

(refer to Fig. 4.)

This test applies to both tone dial and pulse dial (non tone dial) telephones. If tones are heard at the earpiece when digits are pressed, the telephone is a tone dial model; if a series of clicks are heard, it is a pulse dial model. When numbers are dialed faster than 2 digits/second, the tester stores up to 16 digits in its memory and releases them at 2 digits/second. If you wish to clear the DIALED NUMBER DISPLAY, press the RESET/LOW button. This will clear the memory and place a "0" on the display.

1. Toggle the POWER switch ON. The DIALED NUMBER DISPLAY indicator lights when the tester is on.
2. Release the SINGLE/AUX switch to SINGLE.
3. Plug the telephone that you wish to test into TELEPHONE TEST JACK #1. If a telephone is plugged into TELEPHONE TEST JACK #2, make sure that the telephone is hung up (on hook) throughout this test.
4. Hang up telephone under test (place it on hook).
5. Pick up the telephone under test (take it off hook) and listen for the dial tone. If no dial tone is present, this indicates that the telephone will not operate properly and should be repaired or replaced.
6. Press or dial each digit (be sure to use all 10 digits). With tone dial telephones, it is also possible to test the "\*" and "#" keys. The "\*" key displays a decimal point (.) and the "#" displays a bar (-) on the

DIALED NUMBER DISPLAY. Each digit should appear on the DIALED NUMBER DISPLAY in the same order as dialed. The display blinks momentarily each time a new digit is displayed so that, if the same digit is dialed two or more times in a row (example: 177-2266), each individual digit can be distinguished. Also, each time a number is pressed on a tone dial telephone, the VOICE/DIAL LEVEL OK indicator should light. If the numbers do not appear on the DIALED NUMBER DISPLAY in the correct order (or the VOICE/DIAL LEVEL OK indicator does not light each time a number is pressed on a tone dial telephone), the telephone's dialing system is not operating properly and the telephone should be repaired or replaced.

7. It is also possible to test the redial feature of a telephone. To do so, perform steps 2 through 5 of the DIAL TEST and then perform the redial feature for the telephone under test. Each digit should again appear on the DIALED NUMBER DISPLAY in the same order as dialed. If all the digits do not appear in the same order as they were dialed, the telephone's redial function is not operating properly and the telephone should be repaired or replaced.

**TELEPHONE LIGHT TEST**

Power is brought to the auxiliary line pins of TELEPHONE TEST JACK #1 to permit testing of the internal light in "Princess" type telephones or any telephone with a built-in light. When such a phone is plugged into JACK #1 and the SINGLE/AUX switch is in the SINGLE position, the light should be lit unless it is defective.

## OPERATING INSTRUCTIONS

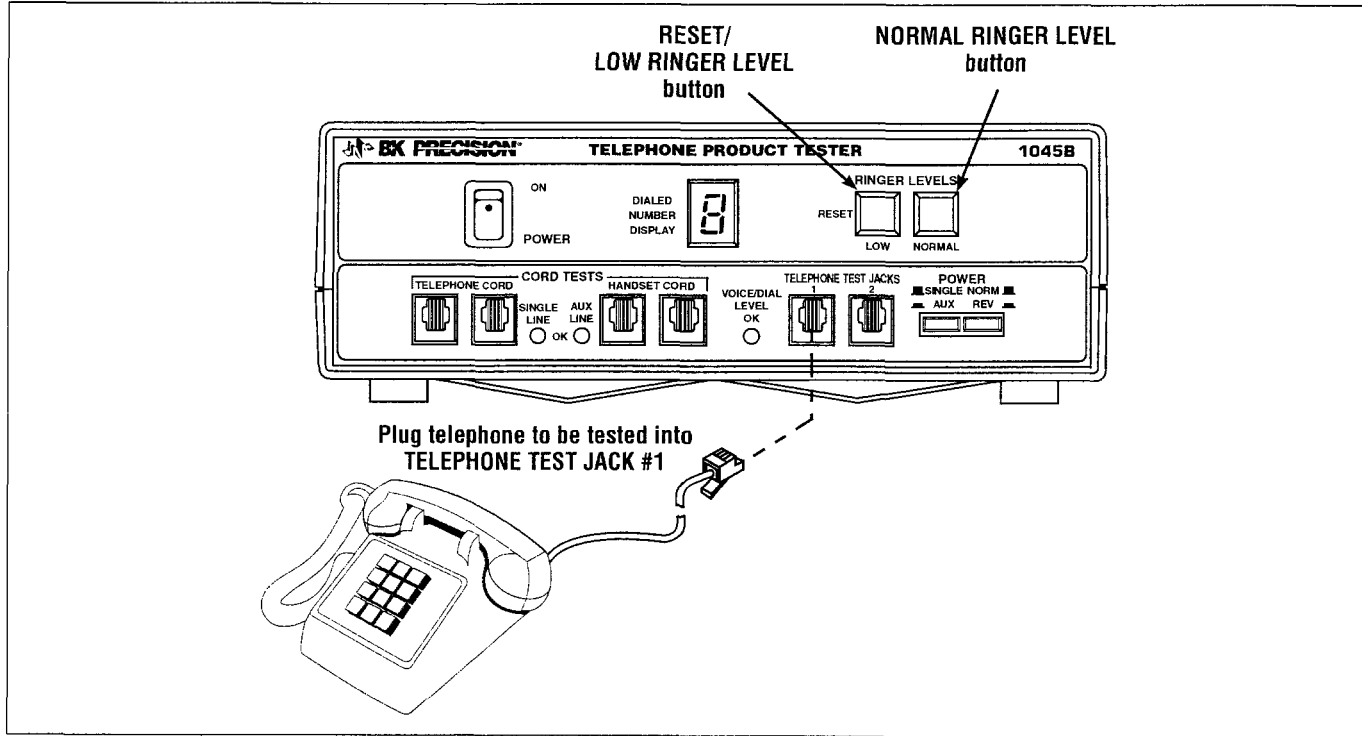

Figure 5. Ring Test Set Up.

**RING TEST**

(refer to Fig. 5.)

**DO NOT HOLD THE TELEPHONE NEAR YOUR EAR DURING THIS TEST**, ringing might be loud enough to cause hearing damage if the telephone rings next to your ear.

1. Toggle the **POWER** switch **ON**. The **DIALED NUMBER DISPLAY** indicator lights when the tester is **ON**.
2. Plug telephone that you wish to test into **TELEPHONE TEST JACK #1** and hang it up (place it on hook). Make sure the **SINGLE/AUX** switch is in the **SINGLE** position.
3. Press the **RESET/LOW RINGER LEVEL** button and the telephone should ring until it is picked up (taken off hook). If the telephone rings in this step, the telephone's ringing device is functioning properly and this completes the **RING TEST**. If the telephone does not ring in this step, go on to step 4.
4. If the telephone did not ring in step 3, press the **RESET** button, then press the **NORMAL RINGER LEVEL** button. The telephone should now ring until it is picked up (taken off hook). If the telephone still does not ring, the telephone's ringing mechanism is not functioning properly and the telephone should be repaired or replaced. If the telephone rings with normal ring voltage but did not ring with low ring voltage, it indicates that the telephone will not work in a long line situation (when the telephone is to be used many miles from a switching station). The telephone should be repaired or replaced. If you wish to listen to the ringback tone while the telephone is ringing,

a second telephone can be plugged into **TELEPHONE TEST JACK #2** and held up to your ear.

**NOTE**

1. Once ringing is initiated at the **LOW** or **NORMAL** ring level, the ring signal can be stopped by pressing the **RESET/LOW RINGER LEVEL** button. This applies whether a phone is connected to **TELEPHONE TEST JACK #1** or not.
2. If a large number of telephone-type devices are connected to a telephone line, they can prevent a good telephone from ringing. If the telephone being tested fails to ring when actually hooked up to a telephone line but rings under this test, exceeding the maximum ringer equivalent could be the cause of the problem. Each telephone identifies its ringer equivalent number. If the total of the ringer equivalent numbers exceeds 5, this could be the cause of the problem.

**VOICE LEVEL TEST**

(refer to Fig. 6.)

1. Toggle the **POWER** switch **ON**. The **DIALED NUMBER DISPLAY** indicator lights when the tester is on.
2. Plug the telephone that you wish to test into **TELEPHONE TEST JACK #1** and pick up the telephone (take it off hook). Make sure the **SINGLE/AUX** switch is in the **SINGLE** position.

## OPERATING INSTRUCTIONS

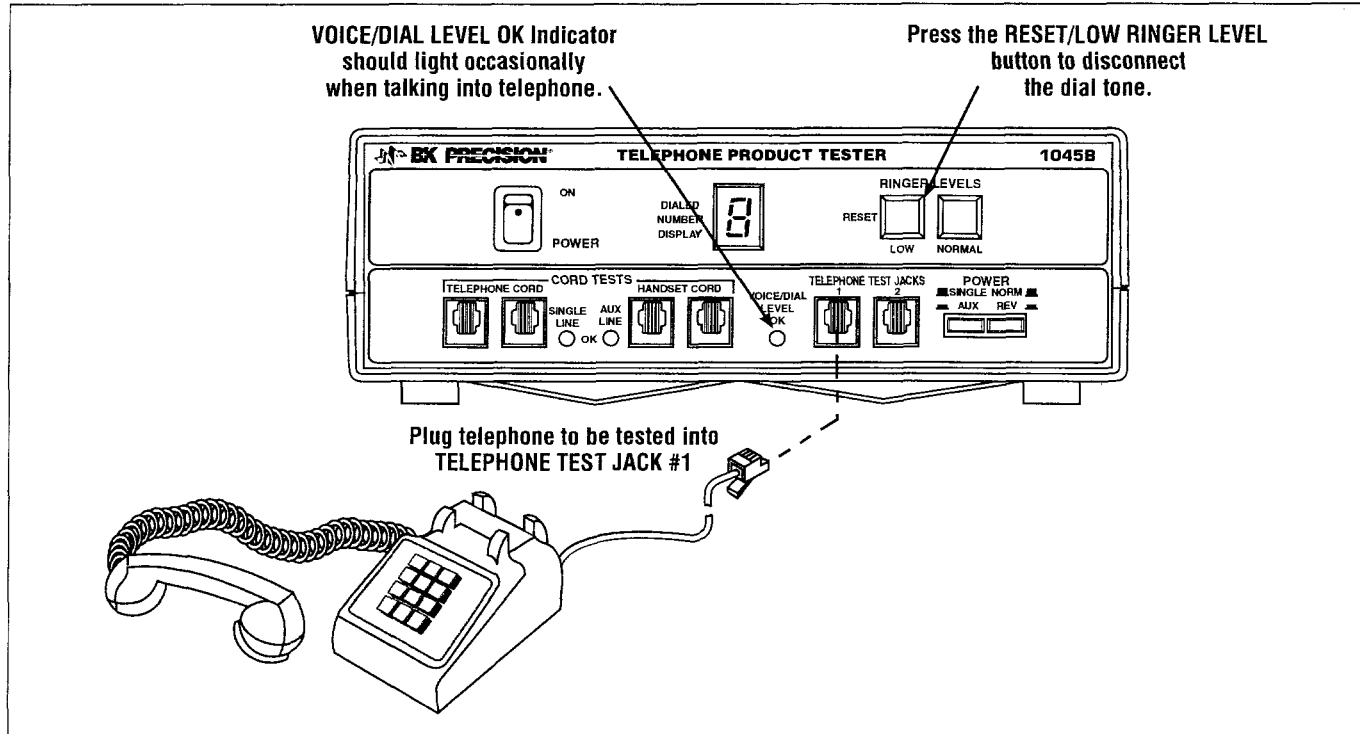

Figure 6. Voice Level Test Set Up.



3. Press the RESET/LOW RINGER LEVEL button to stop the dial tone. It is important to turn off the dial tone while checking the VOICE/DIAL LEVEL OK indicator because the dial tone will cause the tester to read the voice level inaccurately. The VOICE/DIAL LEVEL OK indicator should light or flicker when you talk into the telephone. If the indicator fails to occasionally light while talking into the telephone, the telephone should be repaired or replaced.
  4. Press and hold the POLARITY test button while repeating steps 2 and 3 of the VOICE LEVEL TEST. This reverses the polarity of the power supplied to the telephone and should not affect operation. If results are not the same with the polarity reversed, the telephone should be repaired or replaced.
  5. If you wish to test voice quality, refer to the VOICE QUALITY TEST section of the manual.
- a. From telephone 1, you should be able to clearly hear the person talking into telephone 2 (the telephone that is known to be in working order). This checks the quality of the audio reception of telephone 1.
  - b. The person at telephone 2 should hear you talking into telephone 1. This checks the quality of the audio transmission from telephone 1.
4. Press and hold the POLARITY TEST button while repeating the test. This reverses the polarity of the power supplied to the telephone and should not affect operation. If results are not the same with the polarity reversed, the telephone should be repaired or replaced.

### **TWO-LINE TELEPHONE TEST**

The Telephone Product Tester can test two-line telephones. To test a two-line telephone, perform the following steps:

### **VOICE QUALITY TEST**

To test the voice quality, two telephones are required.

1. Toggle the POWER switch ON. The DIALED NUMBER DISPLAY indicator lights when the tester is on.
2. Plug the telephone that you wish to test into TELEPHONE TEST JACK #1 and a telephone that is known to be in working order into TELEPHONE TEST JACK #2. Make sure the SINGLE/AUX switch is in the SINGLE position.
3. Pick up both telephones (take them off hook). You should now be able to talk and listen as if a telephone call has been completed between the two telephones.

1. Plug the two-line telephone's telephone cord into TELEPHONE TEST JACK #1. Release the SINGLE/AUX switch to the SINGLE (out) position.
2. Test procedures for two-line telephones are identical to test procedures for single-line telephones. Perform each telephone test in this manual to assure that all functions of the telephone are operating properly. This completes the testing of the first communication circuit of the two-line telephone.
3. Push the SINGLE/AUX switch to the AUX (in) position. Perform the telephone test procedures again to verify that the second communication circuit of the two-line telephone is functioning properly.

## OPERATING INSTRUCTIONS

---

### CORDLESS TELEPHONE TEST

The Telephone Product Tester can test cordless telephones. To test a cordless telephone, simply perform the following steps:

1. Plug the cordless telephone's base unit ac power cord into an ac outlet.
2. Plug the cordless telephone's base unit telephone cord into TELEPHONE TEST JACK #1 and release SINGLE/AUX switch to the SINGLE (out) position.
3. Test procedures for cordless telephones are identical to test procedures for regular telephones. Be sure however, to follow the instruction manual for the cordless telephone under test. Perform each telephone test in this manual to assure that all functions of the telephone are operating properly.

### ANSWERING MACHINE TEST

This Telephone Product Tester can also be used to check telephone answering machines. To test an answering machine, perform the following steps:

1. Toggle the POWER switch ON. The DIALED NUMBER DISPLAY indicator lights when the tester is on.
2. Plug the answering machine's ac power cord into an ac outlet.
3. Plug answering machine's telephone plug into TELEPHONE TEST JACK #1 and plug a telephone known to be in working order into TELEPHONE TEST JACK #2.
4. Release SINGLE/AUX switch to the SINGLE (out) position.

5. To cause the answering machine to answer a call, switch the answering machine to the answering mode and pick up telephone 2 (take it off hook). Press the NORMAL RINGER LEVEL button. After enough rings have been generated, the answering machine should answer the call (for example, if the answering machine is set to answer a call after five rings, the answering machine should answer the call after the fifth ring). If the answering machine fails to answer the call, it should be repaired or replaced.
6. Leave the answering machine in the answering mode and keep the telephone plugged into TELEPHONE TEST JACK #2 picked up (off hook). Press the RESET/LOW RINGER LEVEL button and the answering machine should answer the call after the proper number of rings. If the answering machine would not answer the call in this step but did in step 4, the machine cannot be used in long line situations (see RING TEST step 4 for explanation of long line) and should be repaired or replaced.
7. After the answering machine answers the call, you should hear the prerecorded message from the earpiece of the telephone plugged into TELEPHONE TEST JACK #2. When the answering machine gives the tone to leave a message, speak into the telephone to leave a message. Hang up the telephone (put it back on hook) and play back the message.
8. If the answering machine has a remote message playback feature, you can test this also. Repeat step 5, and after the call has been answered, signal the answering machine to playback the messages. You should be able to hear the messages on the telephone plugged into TELEPHONE TEST JACK #2.

**FAX MACHINE TEST**

This Telephone Product Tester can simulate a telephone exchange and two telephone lines for testing fax machines.

1. Toggle the POWER switch ON. The DIALED NUMBER DISPLAY indicator lights when the tester is on.
2. Plug the fax machine's ac power cord into an ac outlet.
3. Plug the telephone plug of the fax machine to be tested into TELEPHONE TEST JACK #1. Plug a second fax machine known to be in working order into TELEPHONE TEST JACK #2.
4. Release SINGLE/AUX switch to the SINGLE (out) position.
5. To cause the fax machine being tested to answer a call, pick up (take off hook) the handset of fax machine 2. Press the NORMAL RINGER LEVEL button. The fax machine being tested should answer the call. If the fax machine fails to answer the call, it should be repaired or replaced.
6. Leave the fax machine in the answering mode and keep the fax machine plugged into TELEPHONE TEST JACK #2 picked up (off hook). Press the RESET/LOW RINGER LEVEL button. The fax machine should answer the call. If the fax machine would not answer the call in this step but did in step 4, the machine cannot be used in long line situations (see RING TEST step 4 for explanation of long line). It should be repaired or replaced.
7. After the fax machine being tested answers the call, you should hear the tones (or observe the message) indicating that it is ready to receive from the handset earpiece (or the message panel) of the fax machine plugged into TELEPHONE TEST JACK #2. When the fax machine gives the tone (or message) to send a document, insert the test document into the sending fax machine and transmit the document.
8. Check the document received by the fax machine being tested to ensure that no problems exist. If the received document is not satisfactory, the fax machine should be repaired or replaced.
9. Transpose the fax machine telephone cords plugged to TELEPHONE TEST JACKS #1 and #2 (plug the fax machine being tested into #2 and the good fax machine into #1). Perform steps 4 through 7 to check the answering and document receiving capabilities of the fax machine being tested. If any problems are evident, repair or replace the machine.

## **OPERATING INSTRUCTIONS**

---

### **AUTOMATIC TELEPHONE DIALER TEST**

1. Plug the automatic telephone dialer's ac power cord into an ac outlet.
2. Program each memory in the automatic dialer to dial any number (it is best to use each digit at least once).
3. Using TELEPHONE TEST JACK #1, hook up the telephone dialer according to its manual.
4. Perform steps 2 through 5 of the DIAL TEST using the automatic dialer in place of the telephone to be tested. Test each memory in the same manner.

### **THE TELEPHONE PRODUCT TESTER AS A DEMONSTRATOR**

The Telephone Product Tester makes a good device for telephone demonstrations.

The Telephone Product Tester can be used to show a person how to operate special features of a telephone. For example, to demonstrate the use of a redial feature, perform the DIAL TEST and the redial function of the telephone.

The tester can also be used to show a person how to operate a cordless telephone. Simply hook up the telephone as described in the CORDLESS TELEPHONE TEST and then go to the desired operation you wish to demonstrate. For example, to demonstrate the dialing procedure, you would perform the DIAL TEST.

## TELEPHONE TROUBLESHOOTING CONSIDERATIONS

When troubleshooting telephone products, it is sometimes desirable to use the Model 1045B Telephone Product Tester and other test instruments simultaneously. For example, the Model 1045B may serve as a signal generator while signals are traced with an oscilloscope. Whenever a telephone is plugged into the Model 1045B the ground lead of any earth grounded instrument should not be connected. Connect only the probe tip and leave the ground lead disconnected. An explanation follows:

When a telephone is plugged into the Model 1045B, one side of the telephone is returned to earth ground through the tester (see illustration). Because of the diode bridge in most telephones, the telephone chassis (signal common) becomes a dc potential with respect to this earth ground point. There is no particular disadvantage to this configuration. In fact, the tester provides exactly the same condition as a telephone plugged into a telephone company jack.

The ground lead of many test instruments such as oscilloscopes, frequency counters, etc. is also returned to earth ground through the power cord. Since the tester already provides one earth ground point in the telephone, an earth grounded test lead of another test instrument should not be connected to the signal common point. To do so shorts one of the diodes of the bridge, as shown in the illustration. Because of the high impedance in series with the  $-52\text{ V}$  supply from the tester, no damage occurs. However, the voltage supplied by the bridge drops to approximately  $0.7\text{ V}$  and the telephone circuits cease operation.

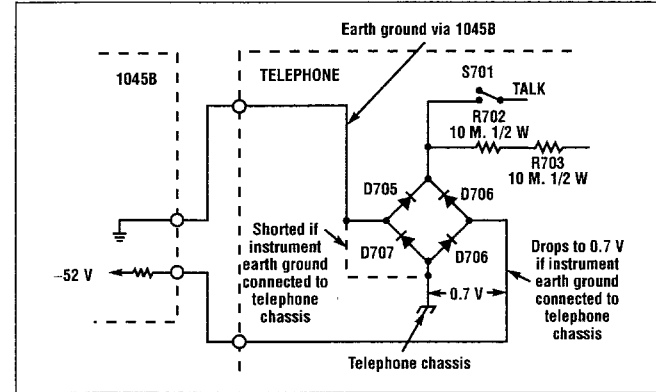

The recommended procedure for oscilloscope use is to leave the ground lead disconnected and use only the probe tip. AC coupled signal measurements are not affected. For dc coupled measurements, the probe tip may be initially touched to the signal common point and the vertical position control set to center the trace as reference. Subsequent measurements then represent the waveform or voltage with respect to the signal common point. If noise becomes a problem with the ground lead disconnected, it may be connected to the earth ground point in the telephone. Both leads of most multimeters are isolated from earth ground, and thus the signal common may be used for reference.

---

## BLOCK DIAGRAM ANALYSIS

(Refer to accompanying block diagram)

---

### Cord Test

For the Cord Test, both ends of a detachable telephone cord are plugged into the appropriate jacks. Two sets of jacks are provided, the TELEPHONE CORD JACKS for checking detachable telephone cords (telephone to wall) and the HANDSET CORD JACKS for detachable handset cords. The two sets of jacks are wired in parallel and either type cord is tested in the same manner, but only one may be tested at a given time. A current is fed through the telephone cord from the +5 V supply through a 330  $\Omega$  resistor. At the other end of the cord, a pair of LEDs are connected between the cord jacks and ground. One LED lights when a 2-wire cord has continuity with no shorts. Both will light for a good 4-wire cord. If the LED(s) fails to light, the cord is defective, either shorted or no continuity.

### Dial Test

For the Dial Test, the telephone to be tested is plugged into TELEPHONE TEST JACK #1. The Off Hook Detector circuit connects the Line Simulator circuit and the Dial Tone & Ringback Signal Generator to the telephone through the POLARITY test switch when the telephone is taken off hook. The Line Simulator circuit applies  $-52$  V through a 1.5 k $\Omega$  resistance. The POLARITY test switch reverses the dc polarity to test the telephone's ability to operate with either polarity. The Dial Tone

& Ringback Signal Generator circuit generates two tones (440 Hz and 352 Hz), mixes them together to produce a precision dial tone, and feeds this tone to the telephone. As soon as the first digit is dialed from the telephone, the dial tone is disconnected and the tones or pulses are fed to the Dialed Number Display Logic circuit. The Dialed Number Display Logic circuit decodes the pulses or tones into a four bit binary logic signal. The four-bit binary code is then fed to the Dialed Number Display delay which stores up to sixteen dialed digits and releases them at approximately 2 digits/second so that they can be easily read from the DIALED NUMBER DISPLAY. The Dialed Number Display delay feeds the code to a decoder/driver which drives the seven-segment LED display.

### Voice/Tone Dial Level Test

The telephone to be tested is plugged into TELEPHONE TEST JACK #1. The Off Hook Detector circuit connects the telephone to the Line Simulator and the Voltage Level Detector through the Polarity Test Switch when the telephone is taken off hook. The Voltage Level Detector rectifies the tone dial or voice signal into a full-wave voltage which is fed to an op-amp. The op-amp feeds the voltage to an LED with a +5 V reference signal connected to the other end. If the voltage applied to the LED is at a level sufficiently above +5 V, the LED lights.

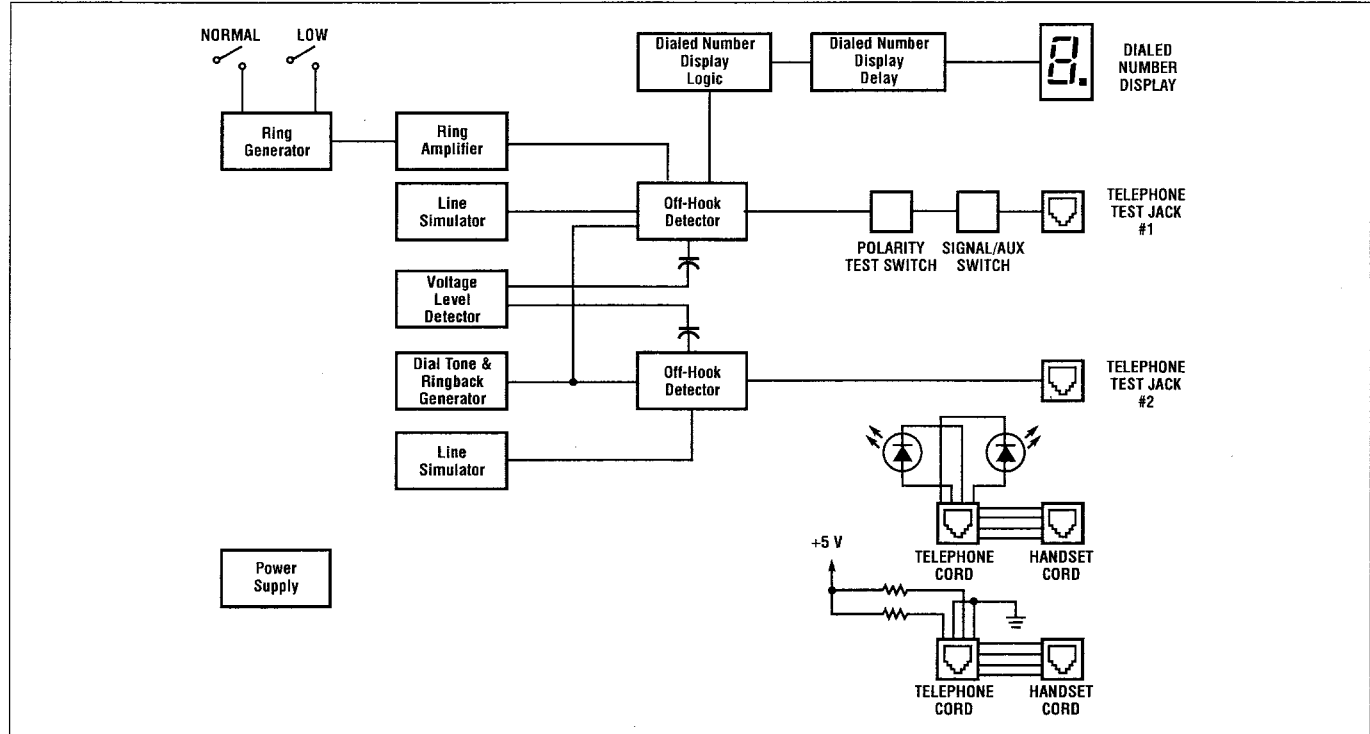

Figure 7. Model 1045B Block Diagram.

## BLOCK DIAGRAM ANALYSIS

---

### Ring Test

For the Ring Test, the telephone to be tested is plugged into TELEPHONE TEST JACK #1. The Off-Hook Detector circuit connects the telephone to the Line Simulator, Ring Generator, and Ring Amplifier through the POLARITY test switch when the telephone is on hook. The Ring Generator produces a 20 Hz square wave ring signal that is on for 2 seconds and off for 4 seconds. The square wave ring signal is then passed through a low pass filter which removes the harmonics and passes a 20 Hz sine wave. The ring signal is amplified to 100 V rms when the

NORMAL RINGER LEVEL button is pressed. The amplifier gain is reduced to provide a 45 V rms ring signal when the LOW RINGER LEVEL button is pressed. The ring amplifier output applies the ring signal through TELEPHONE TEST JACK #1 to the telephone under test. When the telephone is taken off hook, the Off-Hook Detector circuit inhibits the Ring Generator. If a telephone were connected to TELEPHONE TEST JACK #2 and taken off hook during the ring test, a ringback signal of 440 Hz chopped by 20 Hz ringing at 2 seconds on, 4 seconds off, would be produced by the Dial Tone & Ringback Generator.



---

## MAINTENANCE

---

### **WARNING**

*The following instructions are for use by qualified service personnel only. To avoid electric shock, do not perform servicing other than contained in the operating instructions unless you are qualified to do so.*

*Remember that ac line voltage is present on the line voltage input circuits any time the instrument is plugged into an ac outlet. Always unplug the unit before performing service procedures.*

### **DISASSEMBLY AND REASSEMBLY**

In order to access the fuse and the line voltage selector, the top of the case must be removed. Disassembly and reassembly procedures are as follows:

#### **Disassembly**

1. Unplug the unit and turn it upside down.
2. Remove the four screws from the bottom of the case.
3. Turn the unit over, and lift off the top cover.

#### **Reassembly**

1. Line up the slots in the top case half with the front panel and the back panel.
2. Carefully push the top half onto the bottom half.
3. Turn the unit upside down, and replace the four screws.

### **FUSE REPLACEMENT**

If the fuse blows, the DIALED NUMBER DISPLAY will not light and the instrument will not operate.

1. To replace a fuse, disassemble the case as described above.
2. The fuse is located at the rear of the circuit board, to the right of the power transformer.

The fuse should not open unless a problem has developed in the unit. Try to determine and correct the cause of the blown fuse, then replace only with the correct value fuse (3/16 A slow blow for 100 V–120 V operation or 1/8 A slow blow for 220 V–240 V operation.

3. Reassemble case as described above.

### **LINE VOLTAGE CONVERSION**

1. Disassemble the case as described above.

## MAINTENANCE

2. Locate the jumper wire installed behind the power transformer. Observe the designation of each possible jumper; JU8–100V, JU9–120V, JU10–220V and JU11–240V.
3. Unsolder both ends of the jumper and remove it from its present location, using a soldering iron of no more than 25 watts.
4. Insert the jumper in the jumper holes matching the voltage to which you are changing the unit. Solder both ends of the jumper in the jumper holes. Use a soldering iron of no more than 25 watts.
5. For 100V or 120V operation, use a 3/16 amp, 250V, 3AG slow blow fuse.  
For 220V or 240V operation, use a 1/8 amp, 250V, 3AG slow blow fuse.
6. Affix a label showing the correct line voltage and fuse value for the unit after conversion. Place this label directly over the factory label.
7. Reassemble case as described above.

## PULSE DIAL LEAKAGE JUMPER

The minimum impedance during dial pulse break intervals for a ringer equivalence of one varies inversely with frequency. For a frequency of 8 pps, the minimum impedance is approximately 50 k $\Omega$ , about 1 mA leakage. For a frequency of 20 pps, the minimum impedance is approximately 10 k $\Omega$  or about 5 mA. The 1045B has been preset at the factory for 1 mA.

Some phones with special features may have a minimum impedance lower than 50 k $\Omega$  for a ringer equivalence of one. These phones may indicate a wrong digit on the 1045B display and still dial properly in the

telephone network. For these phones, the 1045B pulse dialing leakage detection circuit can be easily modified for proper testing by moving the jumper wire located at JU1 for proper operation as follows:

Jumper	Leakage
JU1	1 mA
JU2	1 mA
JU3	3 mA
JU4	4 mA
JU5	5 mA

When it is necessary to change the Pulse Dialing Leakage Current jumper of the unit, perform the following procedure:

1. Disassemble the case as described above.
2. Locate the jumper wire (JU1, JU2, JU3, JU4, or JU5) installed just forward of the two large power resistors near the right rear quarter of the printed circuit board. Observe the jumper's location and JU designation, which corresponds to the value of leakage current (JU1 = 1 mA, JU2 = 2 mA, etc.).
3. Unsolder both ends of the jumper and remove it from its present location, using a soldering iron of 25 watts, or less.
4. Insert the jumper in the jumper holes matching the leakage current to which you are changing the unit. Solder both ends of the jumper in the jumper holes. Use a soldering iron of 25 watts or less.
5. Reassemble the case as described above.

## CALIBRATION

### General

This instrument was calibrated at the factory before shipment. Readjustment is recommended only if repairs have been made to a circuit affecting calibration or if you have reason to believe that the unit is out of calibration. The calibration adjustment should be attempted only if the proper test equipment is available, and you are properly qualified in its use. If test equipment is less accurate than specified, the accuracy of the instrument will be proportionately degraded. Allow the Telephone Product Tester to warm-up for 1/2 hour before performing calibration.

### **WARNING**

*HIGH VOLTAGE IS PRESENT THROUGH-  
OUT THE UNIT.*

### Test Equipment Required

1. True rms reading multimeter with at least  $\pm 1\%$  accuracy, **B+K PRECISION** Model 391 or equivalent.
2. 1 REN (Ringer Equivalent Number) Load; 0.47  $\mu\text{F}$  in series with 8.2  $\text{k}\Omega$ .

### Calibration Procedure

1. Disassemble the case as described above.
2. Plug the line cord into an AC outlet and turn unit **POWER** to **ON** and set **LINE** switch to **SINGLE** (out).
3. Plug an 1 REN load into **TELEPHONE TEST JACK #1** pins 3 and 4. Connect the multimeter across the load.
4. Momentarily press the **LOW RINGER LEVEL / RESET** button. Adjust **VR1** for a reading of **45.0 V  $\pm 1.0$  V**.
5. Turn off unit power and disconnect multimeter and load from unit.
6. Unplug line cord from AC outlet.
7. Reassemble the case as described above.

## NOTES

- I. **B+K Precision** has supplied a 6-inch telephone extension cable with the Model 1045B. This extension cable helps eliminate repairs to the instrument by reducing wear and tear on the front panel telephone jack. Plug the extension cable into TELEPHONE TEST JACK 1 and leave it connected there. Telephones under test should then be plugged into the receptacle on the end of the extension cable. When the receptacle on the end of the extension becomes worn, the extension cable may be replaced rather than the much more difficult replacement of the front panel receptacle. Order replacement extension cables from the **B+K Precision** Parts Department, part no. 428-220-9-001.

---

## CUSTOMER SUPPORT

### 1-800-462-9832

---

**B+K Precision** offers courteous, professional technical support before and after the sale of their test instruments. The following services are typical of those available from our toll-free telephone number:

- Technical advice on the use of your instrument.
- Technical advice on special applications of your instrument.
- Technical advice on selecting the best instrument for a given task.
- Information on optional accessories for your instrument.
- Information on instrument repair and recalibration services.
- Replacement parts ordering.
- Information on other **B+K Precision** instruments.
- Requests for a new **B+K Precision** catalog.
- The name of your nearest **B+K Precision** distributor.

Call toll-free 1-800-462-9832  
Monday through Friday, 8:00 A.M. to 5:00 P.M.  
Central Standard Time  
(Central Daylight Time in summer)

---

## WARRANTY SERVICE INSTRUCTIONS (For U.S.A. and its Overseas Territories)

---

1. Refer to the MAINTENANCE section of your **B+K PRECISION** instruction manual for adjustments that may be applicable.
2. If the above-mentioned does not correct the problem you are experiencing with your unit, pack it securely (preferably in the original carton or double-packed).
3. Enclose a letter describing the problem and include your name and address.
4. Enclose proof of purchase date; that is, a dated copy of the sales receipt.
5. Deliver to, or ship PREPAID (UPS preferred in U.S.A.) to the nearest **B+K PRECISION** authorized service agency (see list enclosed with unit).

If your list of authorized **B+K PRECISION** service agencies has been misplaced, contact your distributor for the name of your nearest service agency, or write to:

**B+K Precision**  
Factory Service Operations  
1031 Segovia Circle  
Placentia, CA 92870  
Tel (714) 237-9220

Also use this address for technical inquiries  
and replacement parts orders.

---

## LIMITED ONE-YEAR WARRANTY

---

**B & K Precision** warrants to the original purchaser that its product, and the component parts thereof, will be free from defects in workmanship and materials for a period of one year from the date of purchase.

**B & K Precision** will, without charge, repair or replace, at its option, defective product or component parts upon delivery to an authorized **B & K Precision** service contractor or the factory service department, accompanied by proof of the purchase date in the form of a sales receipt.

To obtain warranty coverage in the U.S.A., this product must be registered by completing and mailing the enclosed warranty registration card to **B & K Precision**, 4353 W. Lawrence Avenue, Chicago, Illinois 60630 within fifteen (15) days from the date of purchase.

**Exclusions: This warranty does not apply in the event of misuse or abuse of the product or as a result of unauthorized alterations or repairs. It is void if the serial number is altered, defaced or removed.**

**B & K Precision** shall not be liable for any consequential damages, including without limitation damages resulting from loss of use. Some states do not allow limitation of incidental or consequential damages, so the above limitation or exclusion may not apply to you.

This warranty gives you specific rights and you may also have other rights which vary from state to state.

For your convenience we suggest you contact your **B & K Precision** distributor, who may be authorized to make repairs or can refer you to the nearest service contractor. If warranty service cannot be obtained locally, please send the unit to **B & K Precision** Service Department, 1031 Segovia Circle, Placentia, California 92870, properly packaged to avoid damage in shipment.

**B & K Precision** Test Instruments warrants products sold only in the U.S.A. and its overseas territories. In other countries, each distributor warrants the **B & K Precision** products which it sells.

## MOUNTING THE INSTRUCTION CARD

An instruction card has been included with your Telephone Product Tester. The card provides short, easy to follow instructions that can be used by a non-technical user. It is recommended that the card be mounted in a convenient location for the user. “Velcro” strips are provided to allow versatility when mounting the card. It could be mounted to the top of the tester, or on a wall or counter next to the tester. There are two different types of “Velcro” fabric. Please notice the difference between the two. Be sure to mount the felt material where the card is to be located. To mount the card:

1. Peel the backing from the **felt** material “Velcro” strips.
2. Stick the **felt** “Velcro” strips to the card location.
3. Push the other type of the “Velcro” strips (the loop material) up against the card location.
4. Peel the backing from the loop “Velcro” strips and press the card firmly against them.

