

F1A RINGER

1. GENERAL

1.01 This section contains identification, installation, maintenance, and connection information for the BELL CHIME ringer (Fig. 1 and 2).

1.02 This section is reissued to add information on how to secure the connecting block end of a general purpose set mounting cord when the cord is terminated in the F1A ringer.

1.03 Due to extensive changes, marginal arrows have been omitted.

2. DESCRIPTION

2.01 The F1A ringer is a single coil, high impedance ringer with a 2 position bias spring adjustment. The component parts, shown in Fig. 3, are as follows:

- (a) A die cast base for mounting components; also providing cord clamps for telephone set mounting cord.
- (b) Armature and coil assembly similar to C-type ringers.

(c) A 498A network containing necessary electrical circuit elements and provides a 7-terminal connecting block.

(d) Control lever and switch assembly for selecting either a CHIME, a LOUD ring, or a LOW ring.

(e) Interrupter switch assembly operated by movement of clapper rod to control chime operation. (Earlier model ringers have a 4-leaf spring assembly; later models have 3-leaf spring assembly as shown in Fig. 4.)

(f) A stop bar (Fig. 3) to prevent cover from touching gong assemblies.

2.02 The plastic cover (Fig. 2) is not supplied with the F1A ringer. Order separately as follows:

- Cover 125A-50 (Ivory)
- Cover 125A-63 (Gold)

2.03 The F1A ringer is installed when covered by a service order. Typical installation include:

- Centrally located BELL CHIME ringer
- Extension ringer
- Ringer for 701B (PRINCESS) telephone set
- Loud ringer (substitute for indoor 592A subscriber set)

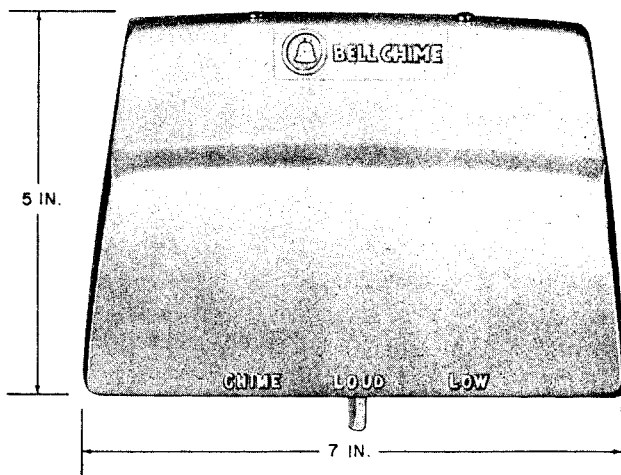

Fig. 1 — F1A Ringer With 125A Cover in Place

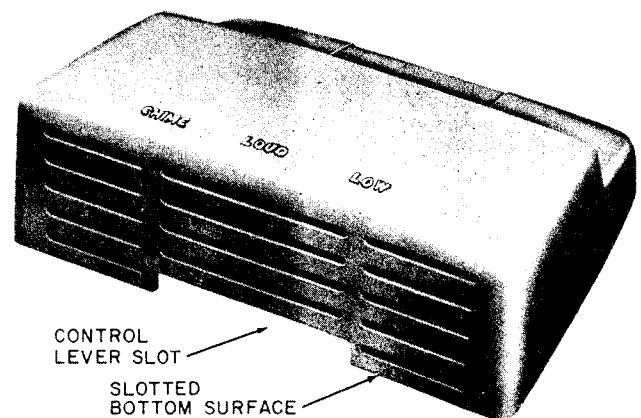

Fig. 2 — 125A Cover

SECTION 501-252-100

2.04 This ringer may be connected with the following classes of service:

- Individual flat and message rate
- 2-party flat and message rate
- Regular PBX stations

2.05 The F1A ringer is not to be used with cold cathode tube or diode-type ringing bridges for the following classes of service:

- 4-party selective
- 8-party semiselective

2.06 In areas where inductive interference requires cold cathode tube-type ringing bridges, the F1A ringer may be connected as shown in the connection practices on ringer and relay type subscriber sets-polarized ringing.

2.07 Since the customer may experience difficulty distinguishing rings in the CHIME position, do not use the F1A ringer with the following code ringing services:

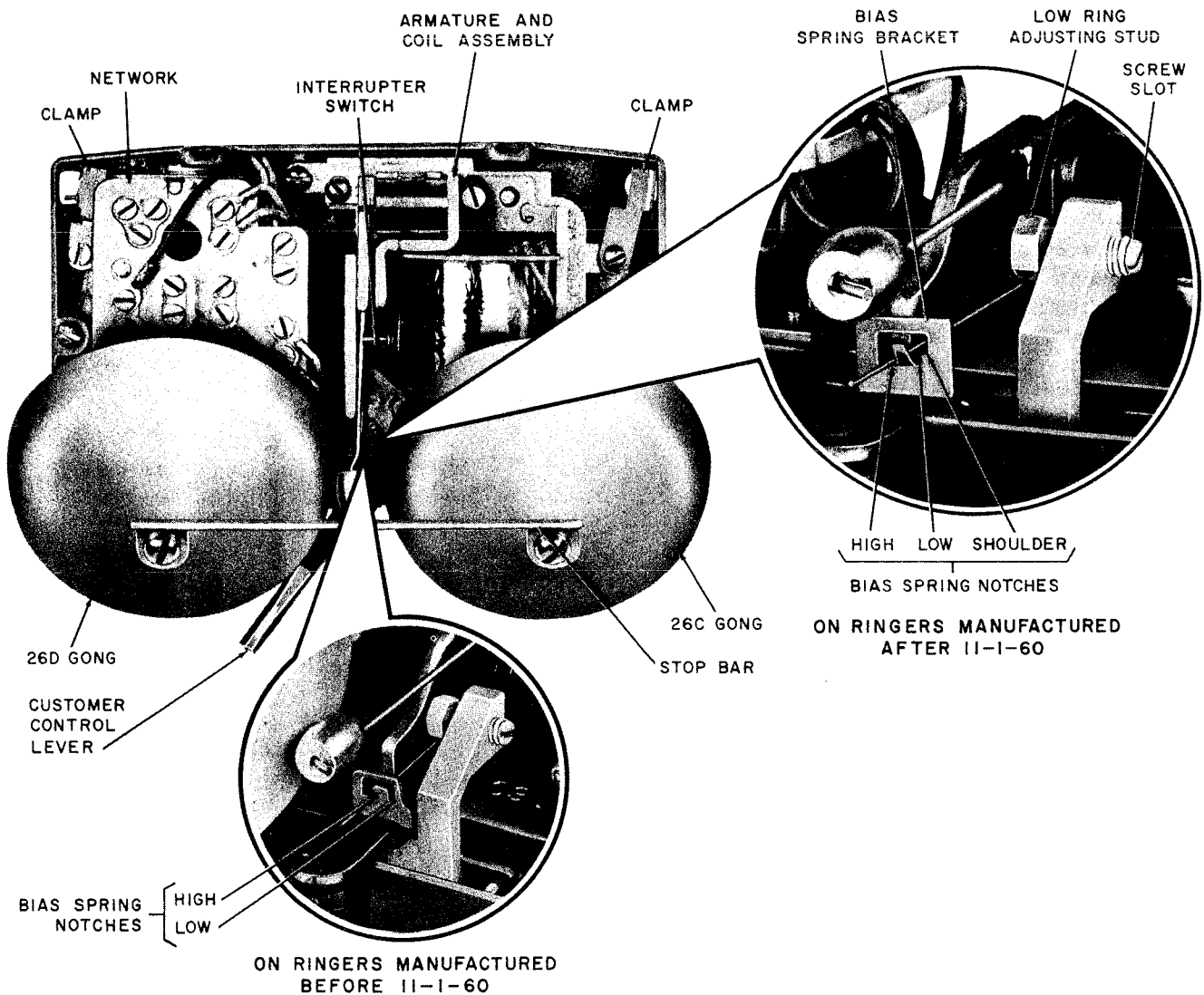

Fig. 3 — F1A Ringer, Components

- Nonselective party lines
- Divided code ringing

3. INSTALLATION

3.01 Suggest a location so customer can hear CHIME or LOW ring in largest area of residence. The F1A ringer will usually provide satisfactory coverage when centrally located on an inside partition about 5 feet above the floor keeping the control level accessible to the customer.

3.02 Ringer locations shall allow space for tightening cover screws on top and adjusting the low ring stud on the right side.

3.03 Standard ringing bridge limitations apply to the use of this high impedance ringer.

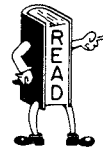

Remove the F1A ringer from shipping carton with care and handle ringer prior to installation with equal care to avoid changing adjustment of interrupter switch assembly. (See Fig. 3.) Keep the F1A ringer in a plastic bag in shipping carton prior to installation. When F1A ringer is removed from shipping carton to be installed, do not leave plastic bag where it is accessible to children. DESTROY PLASTIC BAG IMMEDIATELY. Handle the F1A ringer by using stop bar attached to the two gongs.

3.04 Fasten directly to wall surface with two fasteners. Select length of fastener to provide secure mounting with particular wall material.

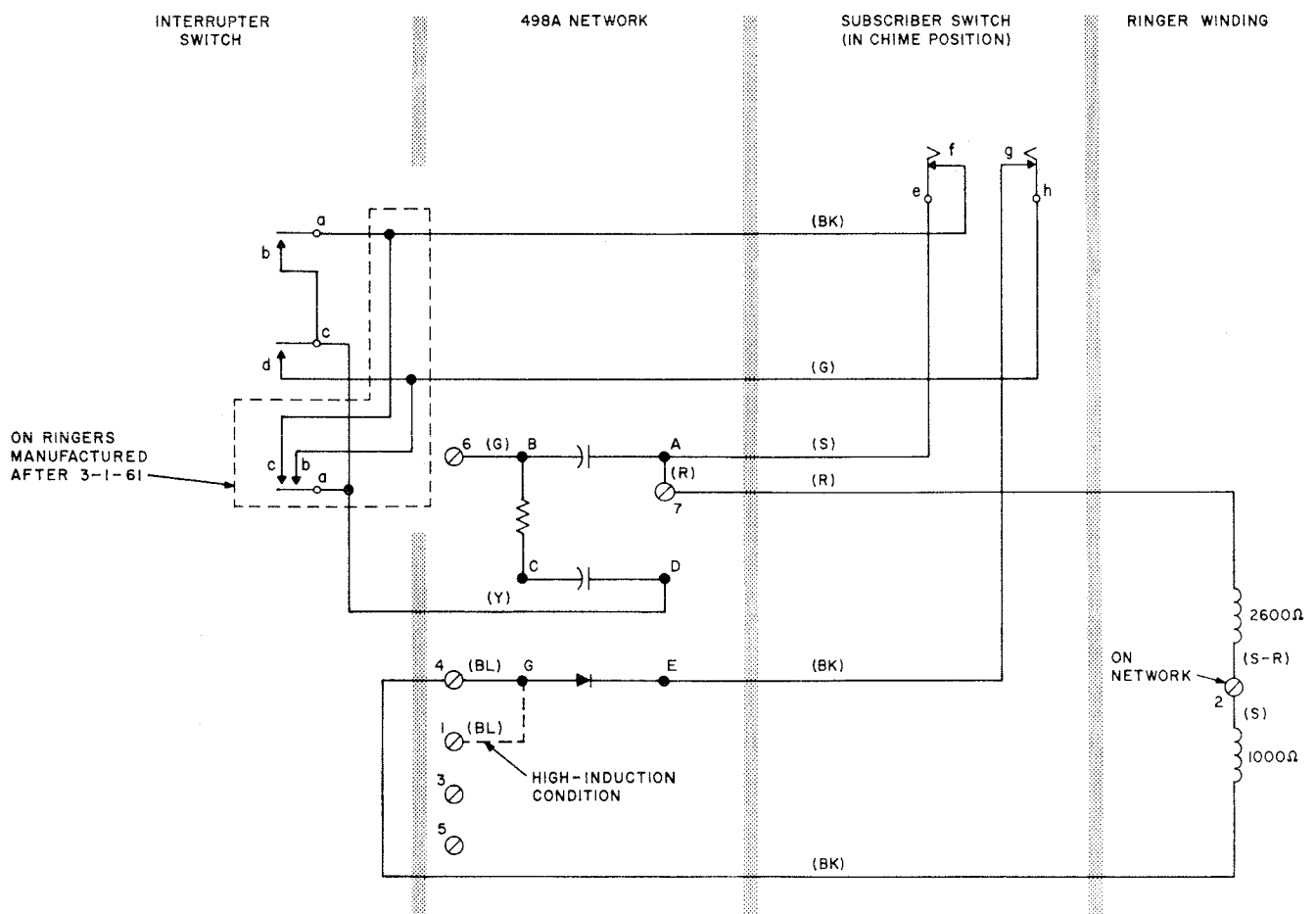

Fig. 4 — F1A Ringer, Schematic

SECTION 501-252-100

- (a) Use No. 8 RH wood screws when fastening to wood, wood studs, or lath.
- (b) Use wall screw anchors on wall surfaces of hollow construction.

3.05 For selection refer to the section entitled Attachments, Fasteners, and Methods for Running Inside Wire and Cable.

3.06 Inside wire may enter ringer from back, bottom, or either side (See Fig. 5 and 6.)

3.07 When inside wire enters ringer from bottom or back, mounting cord from telephone set may be brought into either end of the ringer. When inside wire enters from one end and set cord enters from opposite end, secure set cord ringer with clamps provided.

CAUTION: *On earlier models of the F1A ringer, the interrupter switch assembly was not mounted separately. Loosening the left clamp screw may allow the component plate to shift, changing the position of the interrupter switch. On later models of the F1A ringer (Fig. 3), the rack arm may become displaced from under the 26C gong plate preventing movement of the ringer control lever to either the LOUD or CHIME position. Use care to prevent these conditions when loosening the left clamp screw and fully tighten clamp screw when the set cord is installed.*

3.08 The mounting cords of most telephone sets, other than the 701-type, have short leads at the connecting block end. The cord-stay clamp in the F1A ringer will not keep a pull-strain off the spade tip connections on cords with short leads. To prevent spade tip connection failures in the F1A ringer when using cords with short leads perform one of the following:

- (a) Install a 42-type connecting block using inside wire between the block and the F1A ringer. Terminate the cord in the connecting block.
- (b) Put several wraps of friction tape around the cord a few inches from the stay band. This provides a grommet which should take up the stress against the cord-stay clamp if the cord is pulled.

3.09 Adjust volume of low ring by moving adjusting stud (Fig. 3) right or left; use a small screwdriver in slotted end, located beneath

right gong. Be sure that rack arm does not snag on gong plate.

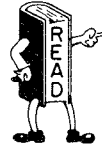

Be sure to acquaint customer with location and use of ringer control lever.

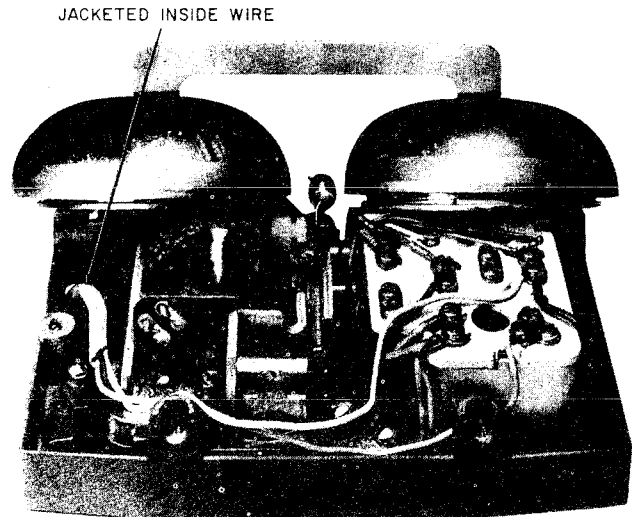

Fig. 5 — F1A Ringer, Top View, Showing Jacketed Inside Wire Entering Through Rear

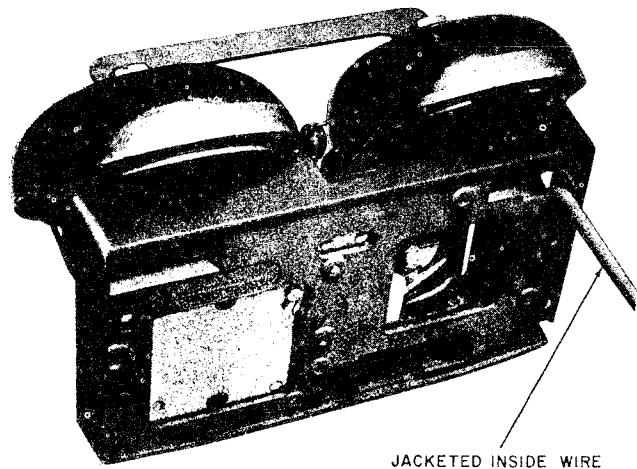

Fig. 6 — F1A Ringer, Rear View, Showing Jacketed Inside Wire Entering Through Rear

TABLE A
BIAS SPRING POSITION

CLASS OF SERVICE		BIAS SPRING NOTCH	REMARKS
Bridged Ringing Service	Individual Flat, Message Rate and PBX Stations	High	The bias spring may be placed in low notch when double tap is experienced in CHIME position or when operation is not satisfactory with bias spring in high notch. If repositioning bias spring results in dial tap or poor operation, check ringer as outlined in Part 6.
Grounded Ringing Service	2-party Flat and Message Rates	High	

4. BIAS SPRING POSITION

4.01 The ringer is shipped with bias spring in high (left) notch. Table A indicates proper position of bias spring for various classes of service. (See Fig. 3.)



Correct bias spring tension has been set at factory. Do not bend bias spring.

4.02 After completing work, obtain a ringing test in all three positions of subscriber switch. Obtain tests according to local instructions. Check for bell taps while dialing.

CAUTION: *Proper poling of the F1A ringer is very important to avoid double-tap in the CHIME position and bell taps while dialing.*

4.03 The biasing spring bracket has been changed on later models of the F1A ringer. (See Fig. 3.)



On later type brackets, bias spring must never be placed on shoulder located to right of low notch.

5. MAINTENANCE

5.01 On a maintenance visit where ringer fails to operate properly, proceed as follows:

- (1) Check airgap at armature for dirt or foreign material and clean if necessary.
- (2) Make sure all connections are tight and *correct*.
- (3) See that all wires are dressed so that they do not interfere with operation of the ringer.
- (4) Clean interrupter switch assembly contacts when required, by carefully burnishing with a 265C tool.



Care must be taken to avoid changing adjustment of spring gap and spring tension of interrupter switch.

5.02 If ringer rings properly but armature sticks in operated position when subscriber switch is in CHIME position, replace ringer.

5.03 If ringer rings with customer control lever in CHIME position, proceed as follows:

SECTION 501-252-100

- (1) Shift network mounting plate until interrupter switch stud just touches clapper rod.
- (2) If step (1) results in double-tap, shift component plate back slightly toward original position.
- (3) If step (1) or (2) does not eliminate trouble, replace ringer.

Note: On earlier models of the F1A ringer the interrupter switch was mounted to the network mounting bracket. On later models the interrupter switch is mounted separately to the ringer base and steps (1), (2), and (3) will not apply.

6. CONNECTIONS

6.01 When tip party identification is required, it must be obtained through the ringer associated with each station. The connections are

shown in the section for particular telephone set used.

6.02 If tip party identification is required and customer does not wish telephone set associated with F1A ringer to ring:

- (a) F1A ringer should not be used to tip party identification.
- (b) F1A ringer should be connected as normal tip party ringer.
- (c) Telephone set should be connected for tip party identification with the ringer silenced as described in the section related to set.

6.03 Table B gives connections for the F1A ringer. A circuit drawing is shown in Fig. 4.

**TABLE B
LINE AND RINGER CONNECTIONS FOR F1A RINGER**

WIRE OR LEAD			INDIVIDUAL OR BRIDGED	RING PARTY	TIP* PARTY
Inside Wire	Ring	R	6	6	1
	Tip	G	4	1	6
	GRD	Y	—	4	4
Ringer		R	7	7	7
		S-R	2	2	2
		S	2	2	2
		BK	4	4	4
Network Straps	G	BL	4	4†	4†
	A	R	7	7	7
	B	G	6	6	6

* See 6.01 and 6.02

† Place BL strap on (1) whenever severe induction noise is encountered.